



# NeuroBlate<sup>®</sup> SYSTEM

INSTRUCTIONS  
FOR USE



**MONTERIS<sup>®</sup>**  
MEDICAL

# NeuroBlate®

S Y S T E M

## INSTRUCTIONS FOR USE

**CAUTION** – Federal (U.S.A.) law restricts this device to sale by or on the order of a physician.



Carefully read all instructions prior to use. Observe all contraindications, warnings, and cautions noted in these directions. Failure to do so may result in patient complications.

### TABLE OF CONTENTS

<b>TABLE OF CONTENTS</b> .....	<b>2</b>
<b>1. SYSTEM DESCRIPTION</b> .....	<b>6</b>
1.1. NEUROBLATE® SYSTEM DESCRIPTION.....	6
1.2. NEUROBLATE OPTIC LASER DELIVERY PROBES & PROBE DRIVER DESCRIPTIONS.....	10
1.2.1. <i>Laser Delivery Probes (LDP)</i> .....	10
1.2.2. <i>SideFire® Optic 3.3 Directional Laser Probe</i> .....	12
1.2.3. <i>Legacy FullFire® Optic Diffusing Tip Laser Probes</i> .....	13
1.2.4. <i>NB3 1.6 Laser Probe</i> .....	13
1.2.5. <i>Laser Delivery Probe Selection</i> .....	14
1.2.6. <i>Robotic Probe Driver (RPD)</i> .....	15
1.3. OPERATING MODES.....	17
<b>2. INDICATIONS FOR USE</b> .....	<b>18</b>
<b>3. CONTRAINDICATIONS</b> .....	<b>19</b>
<b>4. WARNINGS, CAUTIONS, &amp; SAFETY REQUIREMENTS</b> .....	<b>20</b>
4.1. IDENTIFICATION LABELS .....	21
4.2. EQUIPMENT LABELS .....	22
4.3. GENERAL WARNINGS .....	25
4.3.1. <i>Electronics Rack Warnings</i> .....	28
4.3.2. <i>Robotic Probe Driver and Laser Delivery Probe Warnings</i> .....	29
4.4. GENERAL CAUTIONS.....	30
4.4.1. <i>NeuroBlate® System</i> .....	30
4.4.2. <i>Laser Delivery Probes and Robotic Probe Driver</i> .....	32
4.5. GENERAL SAFETY REQUIREMENTS.....	32
4.6. LASER SAFETY .....	32
4.7. INSPECTION, CLEANING, DISINFECTION, STERILIZATION .....	33
4.8. OPERATING CONDITIONS .....	33
4.9. STORAGE CONDITIONS.....	33

<b>5.</b>	<b>MRI CONDITIONAL STATUS</b> .....	<b>34</b>
5.1.	MR IMAGE PROBE SIGNAL VOID .....	35
<b>6.</b>	<b>POTENTIAL HARMS OR HAZARDS</b> .....	<b>36</b>
<b>7.</b>	<b>NEUROBLATE® SYSTEM SETUP</b> .....	<b>37</b>
7.1.	MRI PROTOCOLS AND DICOM IMAGE TRANSFER SETUP .....	37
7.2.	CO <sub>2</sub> TANKS .....	43
7.3.	MRI SHIELD PENETRATION FOR NEUROBLATE CABLING .....	45
7.4.	NEUROBLATE SYSTEM CONTROL WORKSTATION: .....	47
7.4.1.	<i>Software Boot Up and Launch Screen</i> .....	48
7.5.	NEUROBLATE FUSION-S™ SOFTWARE APPLICATION.....	49
7.5.1.	<i>Workflow Task Icons and Description</i> .....	50
7.5.2.	<i>Main Menu Bar Options</i> .....	51
7.5.3.	<i>Toolbar and System Status Description</i> .....	52
7.5.4.	<i>Hardware Interfaces</i> .....	54
7.5.5.	<i>MR Thermal Data Transfer</i> .....	54
7.5.6.	<i>Initiating Data Transfer Interface</i> .....	54
7.5.7.	<i>Thermal Monitoring Slice Planes</i> .....	55
<b>8.</b>	<b>NEUROBLATE® SYSTEM PROCEDURE WORKFLOW</b> .....	<b>57</b>
8.1.	SYSTEM START-UP AND PROCEDURE PRE-PLANNING .....	57
8.1.1.	<i>Fusion-S Software Start Screen</i> .....	57
8.1.2.	<i>Load and Register Image Data within Registration Task</i> .....	59
8.1.3.	<i>Create Region of Interest (ROI) Volumes within the Volumes Task</i> .....	63
8.1.4.	<i>Saving a Plan</i> .....	65
8.1.5.	<i>Opening a Saved Plan</i> .....	66
8.2.	OPERATING ROOM: PRE-PROCEDURE PREPARATION .....	67
8.2.1.	<i>Sterile Probe Delivery Platform</i> .....	67
8.2.2.	<i>Anesthesia</i> .....	67
8.2.3.	<i>Head Fixation</i> .....	67
8.2.4.	<i>Image-Guided Surgery (IGS) System Registration (Non-Sterile)</i> .....	67
8.2.5.	<i>Prepping and Sterile Draping for Trajectory Guidance Devices</i> .....	68
8.2.6.	<i>Image-Guided Surgery (IGS) Registration - Sterile</i> .....	68
8.2.7.	<i>Laser Delivery Probe (LDP) Platform Attachment</i> .....	68
8.2.7.1.	<i>Skull-Mounted Trajectory Devices</i> .....	68
8.2.7.2.	<i>Skull Bone Anchor such as Monteris Mini-Bolt</i> .....	68
8.2.8.	<i>Create a Pathway to the Intended Target</i> .....	69
8.2.9.	<i>Laser Delivery Probe (LDP) Length and Depth Stop Setting</i> .....	70
8.2.9.1.	<i>Length &amp; Depth Stop Setting for 2.2 &amp; 3.3 mm LDP - with a Probe Driver</i> .....	71
8.2.9.2.	<i>Length &amp; Depth Stop Setting 2.2 &amp; 3.3 mm LDP without a Probe Driver</i> .....	71
8.2.9.3.	<i>Length &amp; Depth Stop Setting for 1.6 mm NB3 Probe</i> .....	72
8.3.	PREP FOR TRANSFER TO MRI.....	72
8.4.	INTERFACE PLATFORM (IP) ATTACHMENT/DETACHMENT .....	72
8.5.	PROBE DRIVER ATTACHMENT.....	83
8.5.1.	<i>Workflow using Skull Bone Anchor and Robotic Probe Driver (RPD)</i> .....	84
8.5.2.	<i>Automatic Mode Linear / Rotary Diagnostic Tests</i> .....	85

8.6.	LASER DELIVERY PROBE (LDP) .....	87
8.6.1.	Setting the Laser Delivery Probe (LDP) Depth Stops .....	89
8.6.1.1.	Depth Stop Setting for 3.3 mm and 2.2 mm LDPs - Robotic Probe Driver.....	89
8.6.1.2.	Floating Depth Stop for 1.6 NB3 Probe - Using the Robotic Probe Driver (RPD).....	91
8.6.1.3.	Floating Depth Stop Setting for 1.6 LDP - Inserting Directly Through Mini-Bolt .....	92
8.6.2.	Laser Delivery Probe Connections .....	93
8.6.3.	Cooling Test and Laser Aiming Beam (Pilot Light) Check .....	96
8.6.4.	Laser Delivery Probe (LDP) Insertion .....	98
8.6.4.1.	Insertion of the 2.2 mm and 3.3 mm LDPs .....	99
8.7.	INSERT TASK .....	101
8.7.1.	Probe Placement MRI .....	101
8.7.2.	Software Rendered Probe to Actual Probe Position Match .....	102
8.7.3.	SideFire Probe Beam Direction.....	104
8.7.4.	Acquire Probe Void Scan (GE MRI only) .....	106
8.8.	THERMAL DELIVERY AND MONITORING IN TREAT WORKFLOW TASK.....	107
8.8.1.	Enable the MRI for Real Time Transfer .....	108
8.8.2.	Position Thermal Monitoring Planes in Fusion-S.....	114
8.8.3.	Thermal Sequence Prescription on the MRI .....	117
8.8.3.1.	GE Thermal Sequence Prescription Procedure .....	118
8.8.3.2.	Philips MRI Thermal Sequence Prescription Procedure.....	122
8.8.4.	Initiate Thermal Monitoring in Fusion-S .....	125
8.8.4.1.	For Philips MRI Only (for all other MRI types skip to 8.8.4.2) .....	125
8.8.4.2.	Initiate Thermal Monitoring for all Other MRI Types.....	127
8.8.4.3.	Initiate Delivery of Laser Energy to Tissue .....	131
9.	ELECTRICAL SYSTEM REQUIREMENTS AND TECHNICAL DATA .....	143
10.	TECHNICAL SUPPORT .....	146
11.	CONTACT INFORMATION .....	146
11.1.	DISTRIBUTOR/REP CONTACT: .....	146
11.2.	MANUFACTURED BY: .....	146
12.	TIPS AND TROUBLESHOOTING .....	147

Patent Notice under 35 U.S.C. §287(a): Monteris Medical products and associated processes are subject to the United States patents and pending applications.

NeuroBlate, Monteris Medical, SideFire, FullFire, AtamA, AutoLITT, Monteris Mini-Bolt, the M Logo, the N Logo, the A Logo and Fusion-S Pro are trademarks of Monteris Medical. ©2024 Monteris. All Rights Reserved. ™ and ® denote Trademarks and Registered Trademarks of Monteris Medical Corporation.

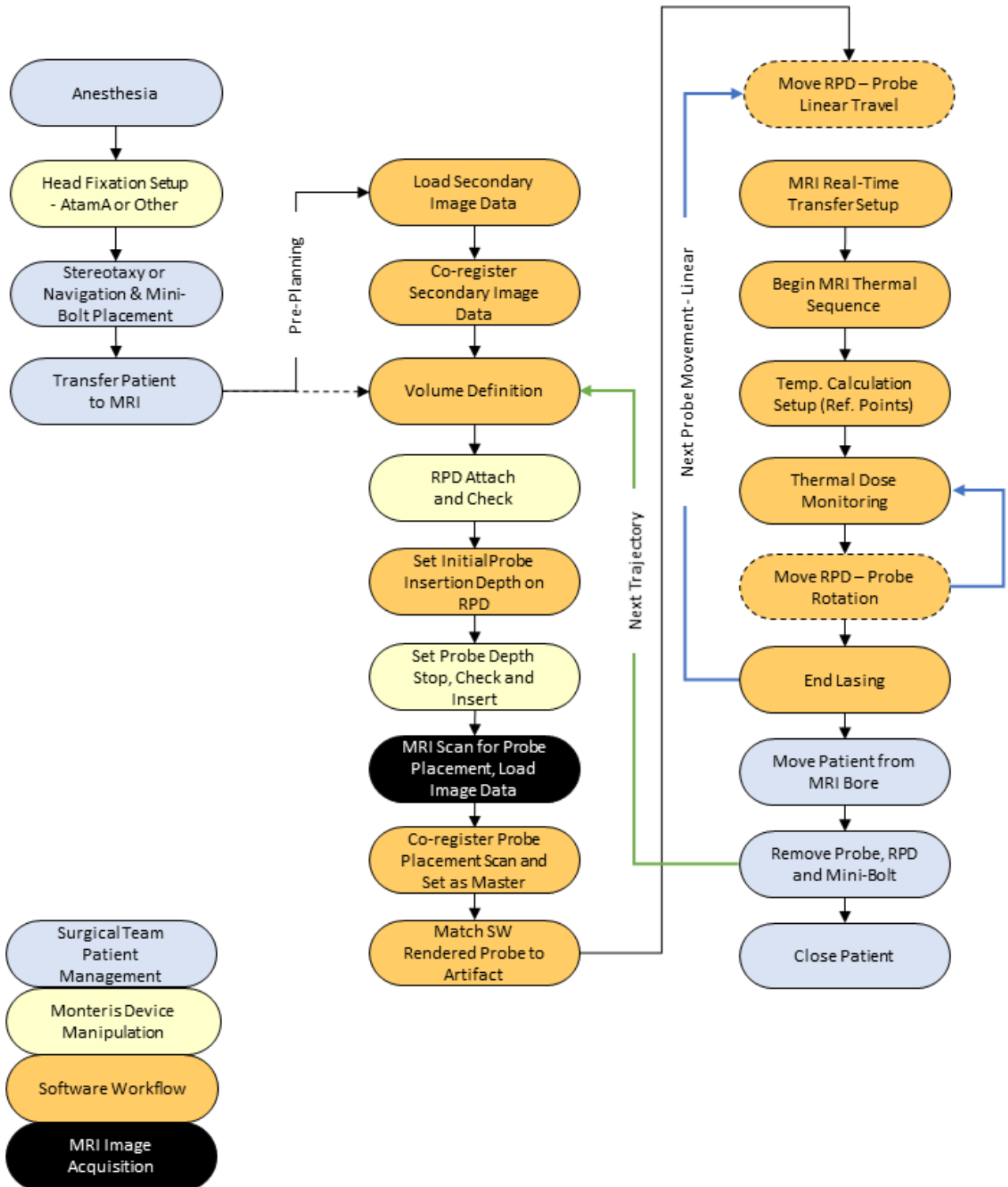

**Flowchart 1: NeuroBlate® System Procedure Overview**





## 1. System Description

### 1.1. NEUROBLATE® SYSTEM DESCRIPTION

The Monteris NeuroBlate® System enables MRI-guided neurosurgical ablation. The NeuroBlate System hardware and disposable accessories are outlined in Table 1.1.



**Table 1.1: NeuroBlate System Product List**

Component	Catalog Number	Description	Other Information
NeuroBlate System	NB102	For use with Siemens, IMRIS, GE, or Philips MRI (see compatible models on page 9)	
Interface Platform	n/a	Resides behind the patient head during MR thermal imaging to manage the electronic connections for the Probe Driver and Laser Delivery Probe as well as the cooling connection.	MRI Conditional (1.5T/3.0T)
System Electronics Rack and Components	n/a	A rolling cabinet which resides in an equipment area adjacent to the MRI containing the system control computers, electronic hardware, laser light source and CO <sub>2</sub> cooling components.	MR Unsafe
Control Workstation containing Fusion-S Software	n/a	A system workstation which resides in the MRI control area and includes a laser foot pedal, keyboard, mouse and display for the graphic user interface	MR Unsafe
NeuroBlate Robotic Probe Driver (RPD)	RPD-01	Lower profile Control device to manage linear translation and rotational manipulation of the Laser Probe during the NB procedure. Attaches to the Interface Platform and appropriate bone anchors.	MRI Conditional (1.5T/3.0T) Sterile Single Use Only 

Component	Catalog Number	Description	Other Information
<b>SideFire® Optic 3.3</b> Directional Laser Probe #000 (133mm) #00 (154mm) #1 (175mm) #2 (196mm) #3 (217mm) #4 (238mm) #5 (259mm)	NBP-000-01 NBP-001-01 NBP-101-01 NBP-201-01 NBP-301-01 NBP-401-01 NBP-501-01	Gas-cooled, directional laser delivery probe (LDP) used to deliver controlled energy to the intended target zone.  The appropriate probe length is determined by the Fusion-S software.  3.3mm Outside Diameter	MRI Conditional (1.5T/3.0T) Sterile Single Use Only 
<b>FullFire® Optic 3.3</b> Diffusing Tip Laser Probe #000 (133mm) #00 (154mm) #1 (175mm) #2 (196mm) #3 (217mm) #4 (238mm) #5 (259mm)	DTP-000-01 DTP-001-01 DTP-101-01 DTP-201-01 DTP-301-01 DTP-401-01 DTP-501-01	Gas-cooled, diffusing laser delivery probe (LDP) used to deliver thermal energy in all directions from the probe tip to the intended target zone.  The appropriate probe length is determined by the Fusion-S software.  3.3mm Outside Diameter	MRI Conditional (1.5T/3.0T) Sterile Single Use Only 
<b>FullFire® Optic 2.2</b> Diffusing Tip Laser Probe #000 (133mm) #00 (154mm) #1 (175mm) #2 (196mm) #3 (217mm) #4 (238mm) #5 (259mm)	FFS000-01 FFS002-01 FFS122-01 FFS222-01 FFS322-01 FFS422-01 FFS522-01	Gas-cooled, diffusing laser delivery probe (LDP) used to deliver thermal energy in all directions from the probe tip to the intended target zone.  The appropriate probe length is determined by the Fusion-S software.  2.2mm Outside Diameter	MRI Conditional (1.5T/3.0T) Sterile Single Use Only 
<b>NB3 1.6</b> Diffusing Tip Laser Probe	FFD-016	Single-length, Gas-cooled, diffusing laser delivery probe (LDP) used to deliver thermal energy in all directions from the probe tip to the intended target zone.  1.6 mm Outside Diameter	MRI Conditional (1.5T/3.0T) Sterile Single Use Only 

Monteris Medical also offers an array of optional disposable and reusable devices (Table 1.2) which can be used for laser probe delivery and skull anchoring as well as head stabilization. These devices are not required for the use of the NeuroBlate System but have been validated to work properly with the NeuroBlate System.

**Table 1.2: Optional Products Validated for Use with the NeuroBlate System**

Item	Catalog Number	Description	Other Information
Monteris® Mini-Bolt	CMB033-S CMB022-S CMB016-S	The Monteris® Mini-Bolt assembly is a disposable, rigid skull fixation device designed to provide a stable platform to deliver neurosurgical devices or instruments.	MRI Conditional (1.5T/3.0T) Provided Sterile Single Use Only 
Mini-Bolt VUE	CMB033-V CMB022-V	The Monteris® Mini-Bolt assembly is a disposable, rigid skull fixation device designed to provide a stable platform to deliver neurosurgical devices or instruments.	MRI Safe Provided Sterile Single Use Only 
AtamA® Stabilization System	ATB002-XX	MR compatible head fixation device for patient immobilization and transfer.	MRI Conditional (1.5T/3.0T)

The NeuroBlate System is compatible with multiple 1.5 T or 3.0T MRI equipment. Please contact your Monteris Representative for facility specific MRI equipment compatibility or refer to the Instructions for Use Supplement (80575 – Compatible MRI Systems Supplement) at [www.Monteris.com](http://www.Monteris.com).



Figures 1.1 and 1.2 below depict the set-up of NeuroBlate System within the MRI suite.

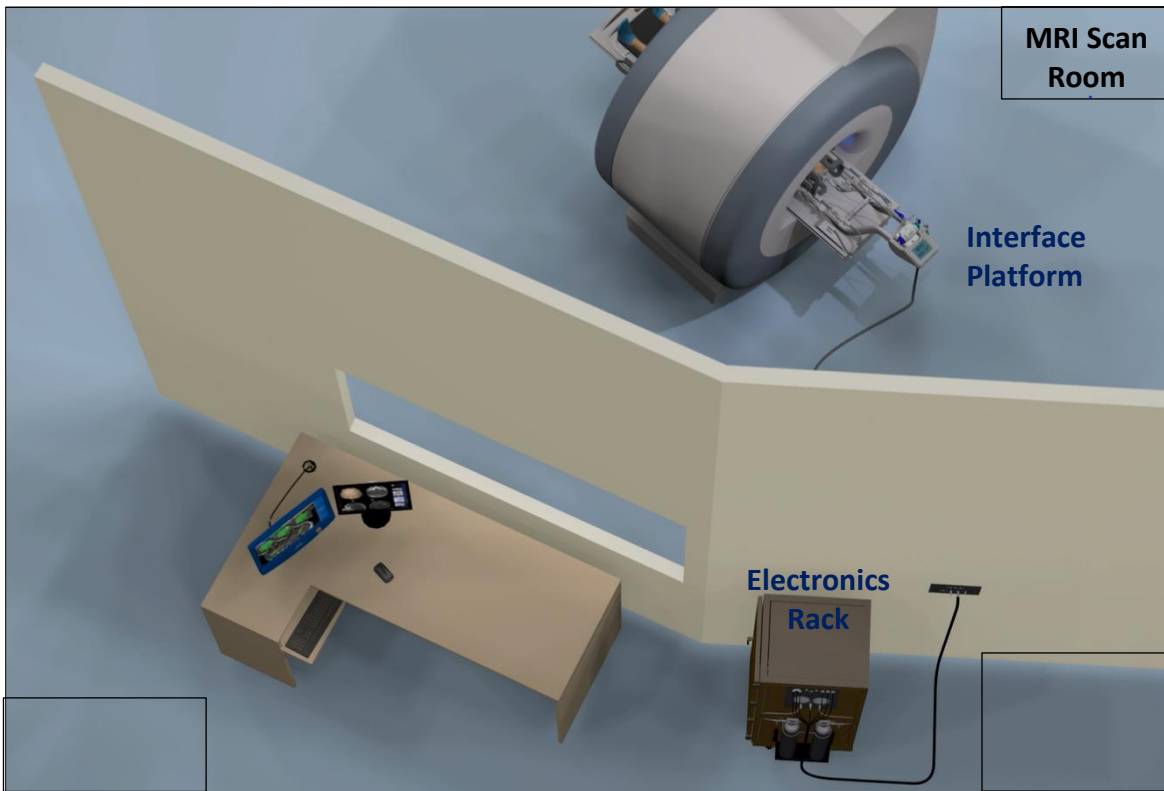

\*The Control Workstation may be Gen 3 as illustrated in Figure 1.1 or Gen 4 as shown in Figure 7.4 on page 47.

\*\* Note, at the HCP request, the Electronics Rack can also be co-located in the MRI Control Room.

**Figure 1.1: Typical Layout of the NeuroBlate System within the MRI Suite**

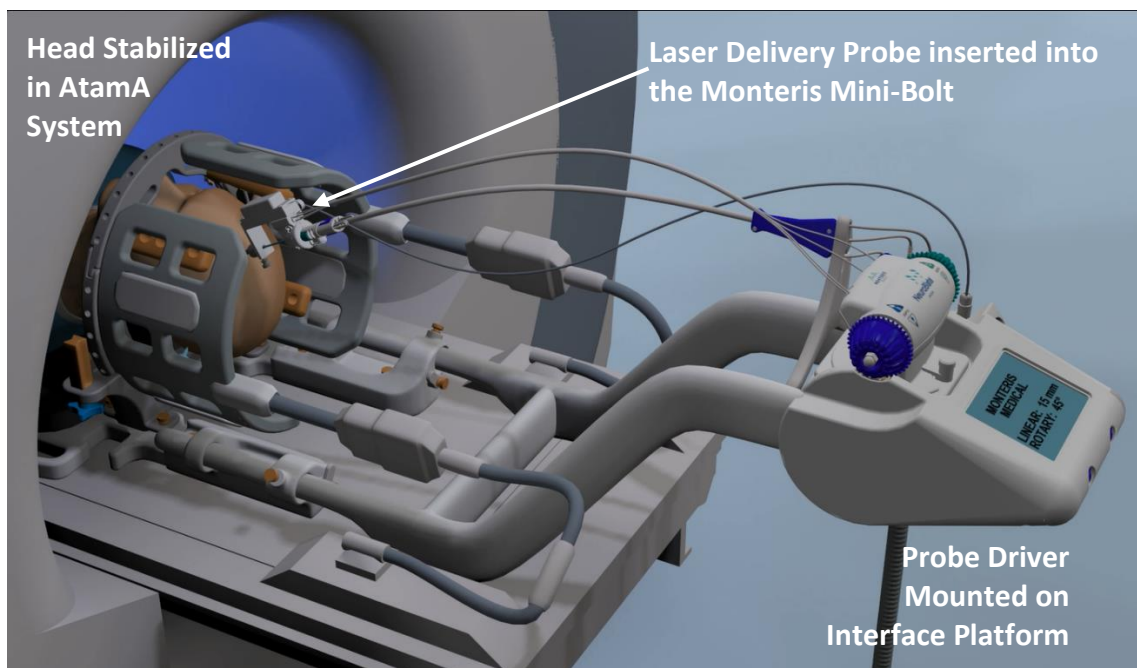

**Figure 1.2: NeuroBlate Components in the MRI Environment**

## 1.2. NEUROBLATE OPTIC LASER DELIVERY PROBES & PROBE DRIVER DESCRIPTIONS

### 1.2.1. Laser Delivery Probes (LDP)

The NeuroBlate System family of laser probes are single-use (disposable) patient interface components used to deliver laser interstitial thermal therapy. The Probe is considered MR Conditional at 1.5T and 3T. The Probe allows for gas cooling during simultaneous laser application and thermal imaging. The laser probes are available in multiple lengths and configurations in three outside diameters: 3.3, 2.2 and 1.6 mm. The appropriate probe configuration and diameter is determined by the physician depending on the clinical need.

The appropriate length for the legacy 3.3 SideFire/FullFire and 2.2 FullFire laser probes is determined with the surgical planning and/or stereotactic platform used for the procedure. The more recent 1.6 NB3 comes as a single length probe and a floating depth stop is set based on surgical planning.

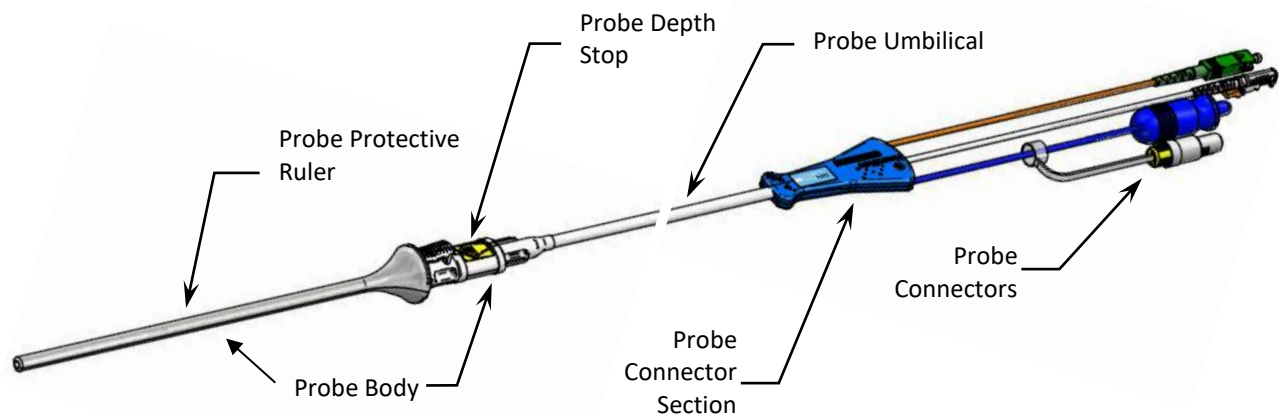
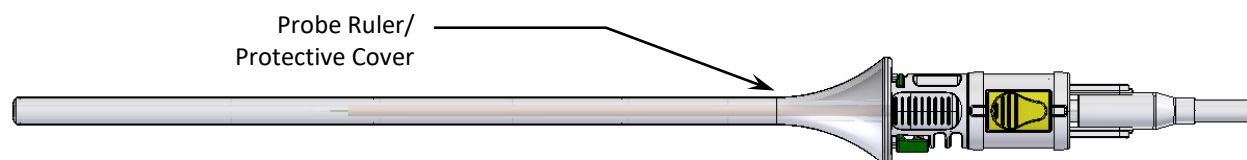
**Figure 1.3: Legacy NeuroBlate Laser Probe**

**Figure 1.4: Laser Delivery Probe Body – Ruler/Protective Cover**

The legacy laser probe assembly (see Figures 1.3, 1.4 and 1.5) is comprised of:

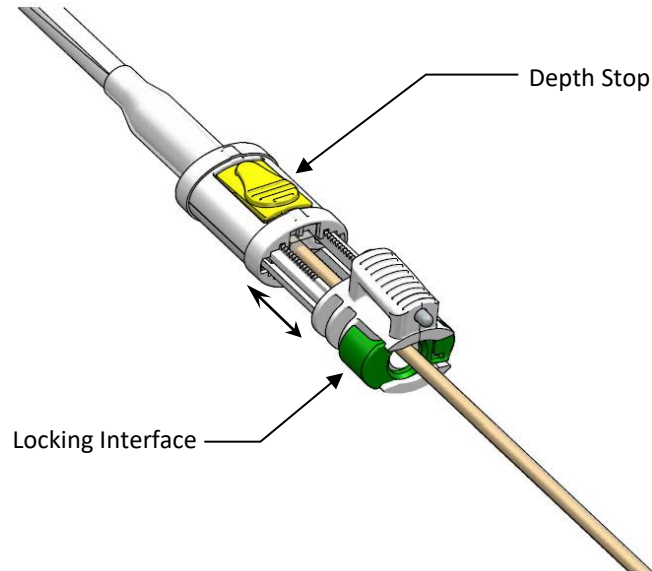
- 1) Removable Ruler/Protective Cover
- 2) Laser Probe Tip (Sapphire Capsule)
- 3) Probe Locking Interface and Depth Stop
- 4) Probe connectors including Temperature Sensor, Laser Fiber, CO<sub>2</sub> Cooling, Probe Detection



**Figure 1.5: LDP Locking Interface and Depth Stop**

The legacy laser probe's Locking Interface attaches to the Robotic Probe Driver Follower or appropriate skull anchoring device such as the Monteris Mini-Bolt. To remove the Ruler/Protective Cover, press the green button on the Locking Interface (Figure 1.5). The Depth Stop (Figure 1.5) is adjustable (see double arrow in Figure 1.5) to allow the LDP tip to be set to the desired depth for insertion into the brain.



**Figure 1.6: NB3 Laser Probe Locking Interface and Floating Depth Stop**

The NB3 1.6 laser probe comes in a single length and contains an adjustable, floating depth stop. It is packaged with the same Ruler/Protective Cover included with the other legacy probes. It also has its own Locking Interface which attaches to the Robotic Probe Driver Follower or appropriate skull anchoring device such as the Monteris Mini-Bolt.

### 1.2.2. SideFire® Optic 3.3 Directional Laser Probe

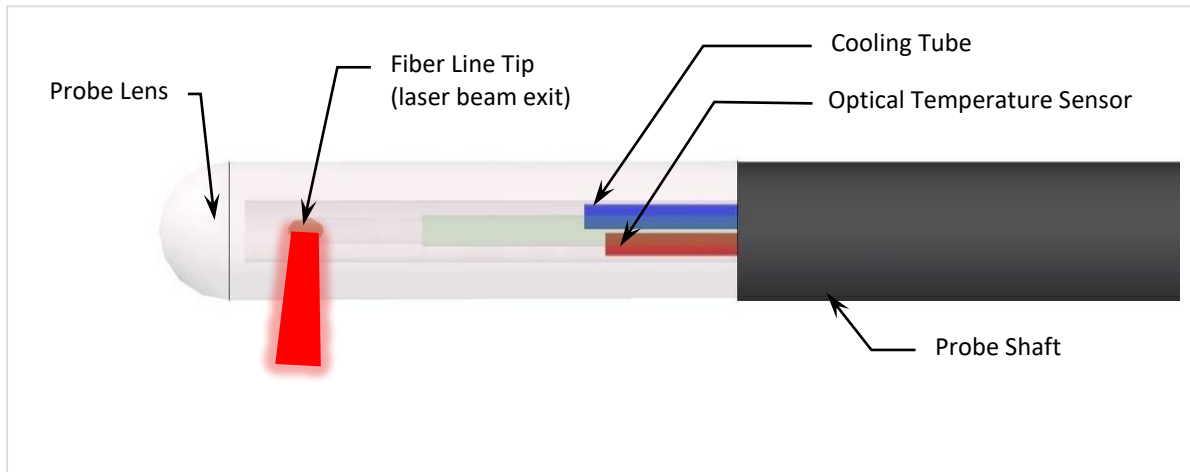
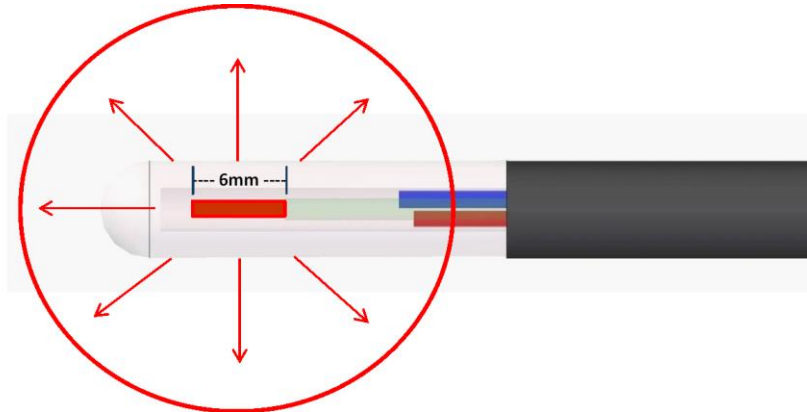

**Figure 1.6: Detail of the SideFire® Optic 3.3 Directional Laser Probe Tip (SFP)**

The SideFire® Optic 3.3 Directional Laser Probe tip (Figure 1.6) is comprised of a clear sapphire lens and the LDP Shaft. The internal components of the LDP can be visualized through the LDP lens.

- An optical fiber terminates inside the lens at the Fiber Line tip and emits controlled laser energy in a uniform direction at approximately 78 degrees from the long axis of the SFP.
- An integrated cooling line circulates CO<sub>2</sub> gas inside the LDP tip to cool during laser delivery.
- A fiber optic temperature sensor measures the temperature of the LDP tip and delivers this information to the Fusion-S software.

### 1.2.3. Legacy FullFire® Optic Diffusing Tip Laser Probes



**Figure 1.22: Detail of the Distal End of the FullFire® Optic Diffusing Tip Laser Probe**

The legacy FullFire® Optic 3.3,diameter FullFire™ Optic 2.2 and NB3 1.6 Diffusing Tip Laser Probes are comprised of the same components and mechanical interfaces as the SideFire. The FullFire probe is differentiated by laser energy dispersion in all directions/dimensions (see representative red arrows Figure 1.22) and emanate from a 6 mm long laser focal (energy emission) area (Figure 1.7).

### 1.2.4. NB3 1.6 Laser Probe

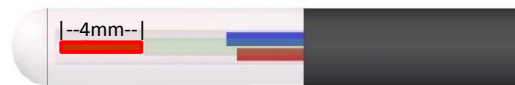

**Figure 1.23: Detail of the Distal End of the NB3 Laser Probe**

The NB3 1.6 Laser Probe lens capsule is made of glass with similar internal components as that of the other FullFire probes. Laser energy is also dispersed in all directions/dimensions from a 4 mm long laser focal (energy emission) area (Figure 1.23).

### **1.2.5. Laser Delivery Probe Selection**

---

Selection of the appropriate laser probe should be determined by the size and shape of the intended ablation area. The SideFire probe provides support for the ablation of irregular shapes based on its ability to selectively ablate with a directional beam. If the safest trajectory does not place the LDP near the center of the target area but closer to one edge, SideFire may be the best choice for focal energy delivery to prevent unwanted heating outside of the target region. The FullFire probes provides support for the ablation of more symmetrical areas with a diffuse beam. The SideFire probe allows conformal control of the ablation area. The NB3 probe may create a more concentric ablation area.

If the target and path to target demands a smaller diameter probe, the FullFire® Optic 2.2 and 1.6 NB3 are suitable laser delivery probes. The selection of a 2.2 or 1.6 probe follows the same considerations noted above. The smaller diameter 2.2 and 1.6 probe achieve target accuracy only if the pathway is first created to the target with an alignment mandrel.

The 1.6 mm diameter NB3 probe comes in a single length with a floating depth stop capable of achieving all desired trajectory depths in the brain.

There may be situations in which both LDP energy emission types (SideFire and FullFire) will be used in succession to achieve optimal thermal dose conformance to the target area. The FullFire probe may be used to ablate initially, followed by insertion of the SideFire probe to ablate additional areas.

### 1.2.6. Robotic Probe Driver (RPD)

The Robotic Probe Driver (RPD) is mounted to the NeuroBlate System Interface Platform (IP) and connected to an appropriate skull bone anchor. The RPD Position Feedback Plug (Figure 1.8) connects to the Interface Platform to communicate the Laser Delivery Probe position in the brain to the system user interface. The RPD rotates or translates (extends or retracts) the NeuroBlate Laser Delivery Probe. The RPD provides linear translation of up to 40 mm and total rotation of 340°.

The RPD is comprised of two components: the Commander and the Follower (Figure 1.8) connected by an umbilical cable. A Rotary Test Adapter is included in older versions of the RPD and can be used during Self-Test to simulate the attachment of a Laser Delivery Probe (LDP) during the procedure if desired. It will be obsolete and not available with newer versions.

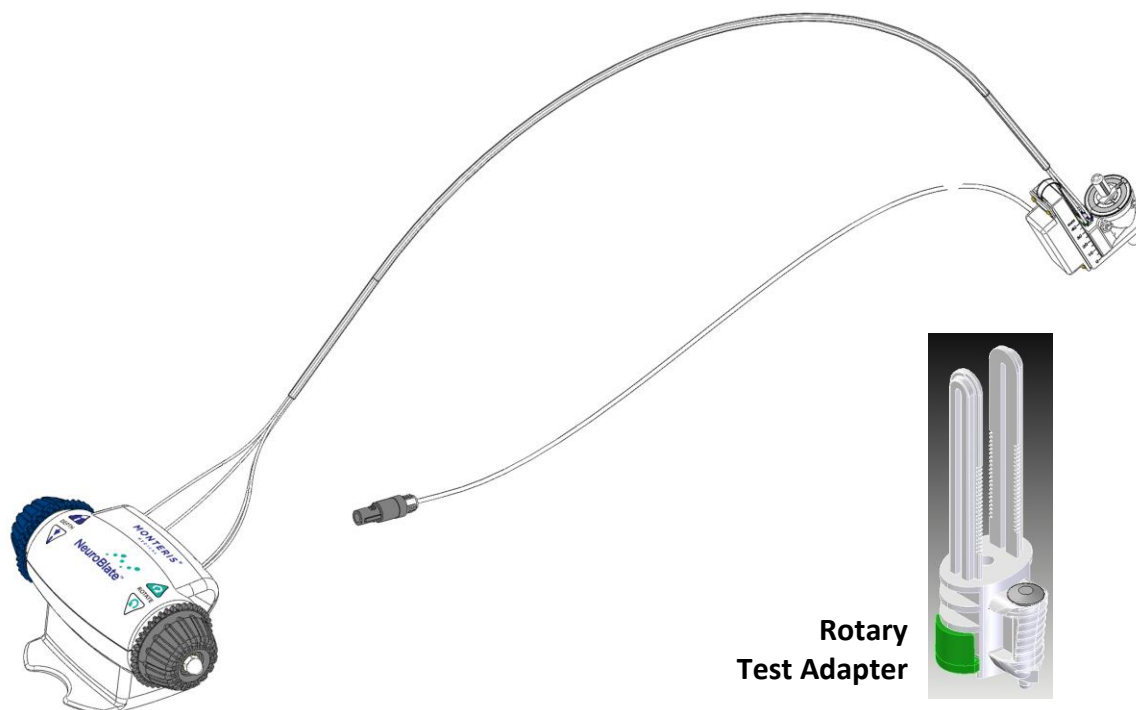

**Figure 1.8: Robotic Probe Driver Components**

- The RPD Commander can be used to manipulate the Laser Probe (translation and rotation) during the procedure in two ways:
  - Manual - the knobs can be manipulated by pressing them in toward the main body of the Commander and turning (knobs will not turn unless pressed in)
    - blue knob controls linear translation
    - green knob controls rotation
  - Remote – the knobs can be managed from the Control Workstation by manipulating the software rendered LDP in the graphical user interface (GUI) of the Fusion-S software.

Figure 1.9 illustrates how the RPD attaches to a skull bone anchor with a thumb screw. With more recently manufactured RPD versions, a scale has been added for visual reference to indicate the linear travel position (older versions will have no scale until inventories are depleted).

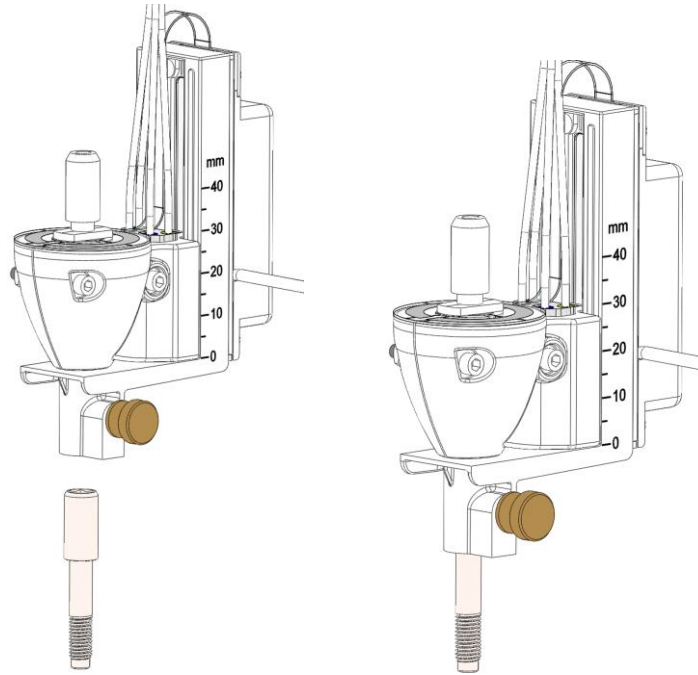

**Figure 1.9: Attachment of the RPD Follower to a skull bone anchor**



---

### 1.3. OPERATING MODES

---

The NeuroBlate System has 2 modes of operation, Active and Standby. These modes are defined by 5 essential functions the system can provide and more specifically, the state of each function. The system is in Active mode if at least one Essential Function is activated (shown “in operation” on the system Control Workstation screen). The five essential functions are:

1. DICOM file transfer from MRI (receive)
2. Probe cooling
3. Probe (Probe Driver) linear and rotary travel
4. Laser *Ready* (enabled for laser emission) or *Laser* (laser emission is active)
5. Emergency Stop\*
  - a. Disables Probe Cooling, Probe linear and rotary Travel and Laser
  - b. Sounds alarm

\* Emergency Stop switch (red buttons) are located on the NeuroBlate Control Workstation, Electronics Rack and on a box setting on floor or shelf inside the MRI scan room.

The system is in **Active mode** if at least one essential function is activated as noted, or at least one of the following:

- Receiving files through the Ethernet connection
- Probe is cooling
- Probe (via RPD) is in motion (linear or rotary)
- Laser is shown in *Ready* mode on the Control Workstation screen (enabled for laser emission)
- Laser is shown as *Laser* mode on the Control Workstation screen and audible beeping is heard (laser emission is active)
- Emergency Stop has been pressed/engaged

The system is in **Standby mode** if the system is fully turned on but none of the Essential Functions are in active mode, meaning:

- Not receiving any files through Ethernet connections
- Probe is not cooling (or not commanded to cool)
- Probe is not in motion (or not commanded to move in either linear or rotary axis)
- Laser is in “Standby” mode (or disabled)
- Emergency Stop has not been engaged

## 2. Indications for Use

The Monteris Medical NeuroBlate System is a neurosurgical tool and is indicated for use to ablate, necrotize, or coagulate intracranial soft tissue, including brain structures (e.g., brain tumor, radiation necrosis, and epileptogenic foci as identified by non-invasive and invasive neurodiagnostic testing, including imaging), through interstitial irradiation or thermal therapy in medicine and surgery in the discipline of neurosurgery with 1064 nm lasers.

The Monteris Medical NeuroBlate System is intended for planning and monitoring thermal therapies under MRI visualization. It provides MRI-based trajectory planning assistance for the stereotaxic placement of MRI compatible (conditional) NeuroBlate Laser Delivery Probes. It also provides near real-time thermographic analysis of selected MRI images.

When interpreted by a trained physician, this System provides information that may be useful in the determination or assessment of thermal therapy. Patient management decisions should not be made solely on the basis of the NeuroBlate System analysis. The intended patients are adults and pediatric from the age of 2 years and older.

### 3. Contraindications

The following are contraindications that apply to the NeuroBlate System:

- Patients who are contraindicated for MRI, including patients who may have contraindications due to implanted medical devices.
- Patients who the physician determines are not appropriate candidates for laser interstitial thermal therapy (LITT).
- Patients who are not candidates for invasive surgical procedures in the brain.



































## 4. Warnings, Cautions, & Safety Requirements

**CAUTION:** Alerts you to situations that may result in system or equipment damage, failure in a procedure, or incorrect results e.g., any special care to be exercised by the user for the safe and effective use of the device.

**WARNING:** Alerts you to situations that may result in serious adverse reactions, bodily harm or irreparable damage to the system or equipment, e.g., potential safety hazards, limitations in use, and steps that should be taken if such events occur. Additionally, an appropriate warning is provided when there is reasonable evidence of an association of a serious hazard with the use of the device. A causal relationship need not have been proved.

Symbols displayed on the NeuroBlate System or documentation are below.

#### 4.1. IDENTIFICATION LABELS

	<b>MR Unsafe</b> - item is <b>NOT</b> MRI compatible and is known to pose a hazard in MR environments. This equipment should not be taken into the MRI room within the 5 Gauss perimeter line.		
	<b>MR Conditional</b> - the item poses no known hazards in a specified MRI Environment (e.g. 1.5T to 3.0 T)		
	<b>MR Safe</b> - the item poses no known hazards in ALL MR environments.		
	High Voltage present. Electrical hazard. Authorized personnel only.		
	Caution followed by text message.		Follow instructions for use
	Equipotentiality		Keep away from sunlight
	Serial Number		Protective earth
	Do Not Use if Package is Damaged		Type BF Applied Part
	Do not re-sterilize		Single Use
	Sterilized Using Ethylene Oxide		Laser Radiation
	Manufacturer		Batch code
	Use-by Date		Product Size
	Catalog Number	PN:	Part Number
	Consult Instructions for Use	QTY:	Number of Products
	For Prescription Use Only		Date of Manufacture
	For indoor use only		RoHS: Restriction of the use of certain hazardous substances in electrical and electronic devices.
	Electrical/electronic equipment in accordance with the Directive 2012/19/UE (WEEE). Do not dispose with domestic household wastes.		
	Power Switch		AC Power Cord
	Power On / Power Off		Foot Switch
	USB	<b>CW2</b>	Control Workstation 2 I/O Connection
	Laser Fire Volume	<b>KVM1</b>	Keyboard Video Mouse 1
	DisplayPort	<b>KVM2</b>	Keyboard Video Mouse 2

## 4.2. EQUIPMENT LABELS

### Dornier Laser:



### Quantel Laser:

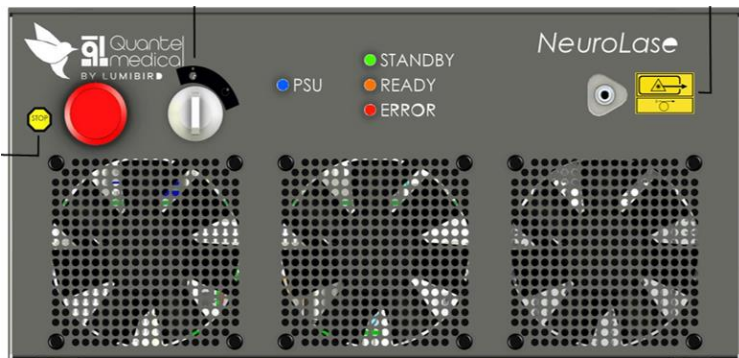

	<b>LASER FIBER APERTURE:</b> Located next to the laser aperture		
	<b>KEY POSITION:</b> Indicates the “OFF” and “ON” positions of the key		
		“OFF” for a part of equipment	
	<b>EMERGENCY STOP:</b> Located next to the red emergency stop button		

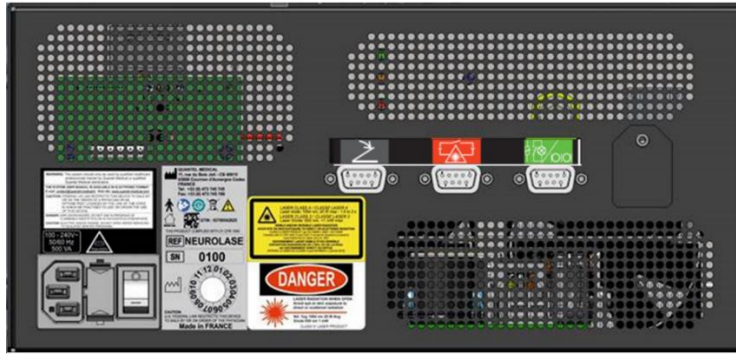

	<p><b>FUSES &amp; VOLTAGES:</b> Specification of voltages, current, frequencies, power and fuses</p>				
	<table border="1" data-bbox="850 667 1419 764"> <tr> <td></td> <td>Fuse</td> </tr> <tr> <td></td> <td>Alternative current</td> </tr> </table> <p><b>DANGER RADIATION LASER</b> Specification of laser beam (treatment and viewfinder):</p> <ul style="list-style-type: none"> <li>- Laser class</li> <li>- Wavelength</li> <li>- Maximum power</li> <li>- Exposure time</li> </ul>		Fuse		Alternative current
	Fuse				
	Alternative current				
	<p>Door switch</p>				
	<p>Footswitch</p>				
	<p>Door Lamp relay/ RS232 COM</p>				
<p><b>WARNING:</b> The system should only be used by qualified healthcare professionals trained by Quantel Medical or qualified Quantel Medical distributors.</p> <p><b>THE SYSTEM USER MANUAL IS AVAILABLE IN ELECTRONIC FORMAT.</b> E-mail: <a href="mailto:contact@quantel-medical.fr">contact@quantel-medical.fr</a> Web site: <a href="http://www.quantel-medical.com">www.quantel-medical.com</a></p> <p><b>CAUTION:</b> FEDERAL US LAW RESTRICTS THIS DEVICE TO SALE TO OEM CUSTOMER.</p> <p><b>DANGER:</b> EXPLOSION HAZARD. DO NOT USE IN PRESENCE OF FLAMMABLE ANESTHETICS OR IN OXYGEN-RICH ATMOSPHERE.</p> <p><b>CAUTION:</b> ELECTRIC SHOCK HAZARD. DO NOT OPEN. REFER SERVICING TO QUALIFIED SERVICE PERSONNEL.</p>					

**NeuroBlate System:**

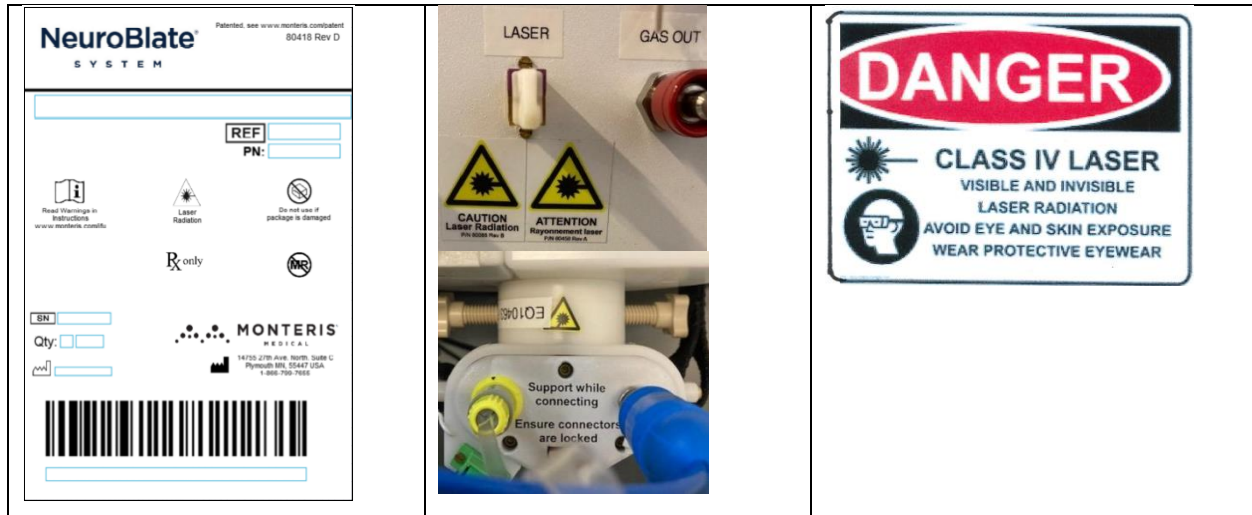

**NeuroBlate System with Dornier Laser:**

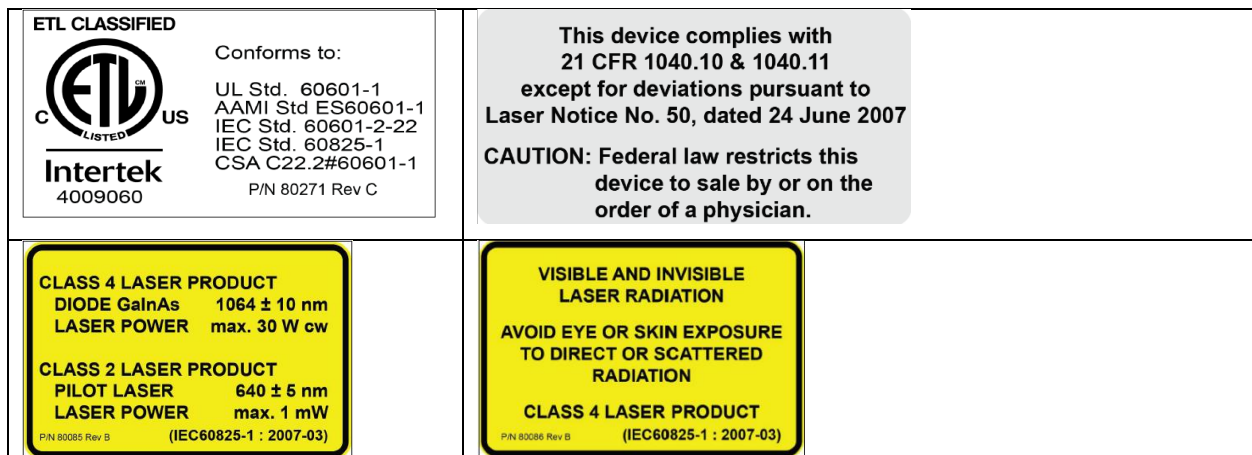

**NeuroBlate System with Quantel Laser:**

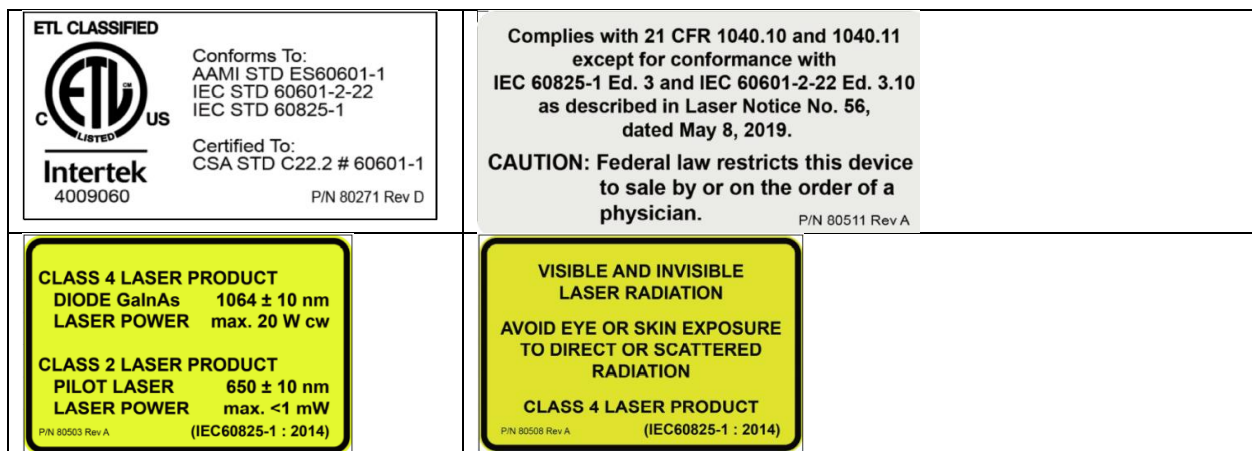



---

### 4.3. GENERAL WARNINGS

---



The following are general warnings that apply to the NeuroBlate System as a whole; please consult the complete NeuroBlate System IFU for device specific instructions for all accessories used (such as the Laser, Monteris AtamA, and system MRI) for warnings specific to those devices.



---



**WARNING:**

---

- Damaging the lens may result in malfunction that may increase the risk of CO<sub>2</sub> release and potential of lens material being left in the brain.
- Laser Delivery Probe advancement into, or laser ablation in cerebral vasculature or highly vascularized targets (especially in patients with predisposition to bleeding) may result in hemorrhage.
- Inserting the probe along the trajectory to the target tissue, and/or laser ablation near eloquent brain areas, may result in collateral damage to anatomical structures and related patient complications.
- Perioperative complications for brain surgeries such as MRI-guided neurosurgical ablation may include: sensory, cognitive, or motor deficits; hemorrhage; brain edema/swelling; seizures; general weakness/paralysis; pain; infection (e.g., meningitis or surgical site infection); bone fracture; allergic anaphylactic reaction; cardiac arrest; or death.
- The minimally invasive nature of the procedure may result in noticeable effects of edema/swelling—consider prophylactic steroid administration for all patients and use extreme caution in ablating targets greater than 20cc.
- Increased variability of heat conduction and MRI thermometry in areas of dissimilar tissues and heat sinks (e.g., near the brain surface, near bone, near large volumes of cerebral spinal fluid, near large blood vessels) may increase the risk of collateral damage to tissues adjacent to the targeted lesion.
- Image artifacts due to nearby devices (e.g., trajectory devices such as the Monteris Mini-Bolt) may impair MR thermal imaging and therefore the estimation of the tissue temperature near the surface of the brain. Such artifacts may result in an inability to monitor thermal damage which may lead to unintended tissue damage.
- Continued ablation in the presence of MR imaging artifacts may result in unintended tissue damage.
- Repeated insertions of a laser probe may increase the risk of surgical complications.
- The system must be operated by trained personnel under the direct supervision of a trained physician.

- Color perception is extremely important during temperature monitoring. Operators who are color blind or have impaired color perception may not be able to monitor temperature during the procedure, which may result in patient injury or death.
- Laser eye protection provided with the NeuroBlate system must be worn in the MRI Scanner room during operation of the laser.
- Using eye protection other than what was specifically provided with the NeuroBlate system may not provide adequate protection for the NeuroBlate laser wavelength.
- Use only the eye protection that was specifically provided with the NeuroBlate system as others may affect color perception and the interpretation of thermal images and indicators.
- Use only Monteris Medical approved (MRI compatible) accessories with this equipment. Failure to do so may result in improper performance and/or damage to the equipment with potential to cause harm.
- Only use Monteris Medical approved MRI sequences for thermal imaging in conjunction with this equipment. Failure to do so may result in improper thermal monitoring which may lead to patient injury.
- Ensure that all loaded image data contains the correct patient identification and image orientation markers prior to the commencement of the NeuroBlate procedure to ensure an unintended area of the brain is not targeted for thermal delivery which may lead to patient injury.
- Failure to determine an accurate baseline temperature may result in inaccurate temperature monitoring and thermal dose estimation with the potential to cause patient injury.
- MRI is contraindicated for patients with certain metallic, electronic or mechanical implants, devices or objects that must not enter the MRI scan room or serious injury may result. Follow institution guidelines in making this determination.
- The use of trajectory devices other than the Monteris Mini-Bolt with the Probe Drivers to insert the Laser Delivery Probe is untested and may result in probe failures such as laser fiber breakage, probe lens separation or cooling failures. These failures may require additional surgical intervention or lead to patient injury.
- CO<sub>2</sub> tank valves must be closed before replacing; otherwise serious operator injury may result.
- Extreme care should be exercised during visual verification of image registration. Inaccurately registered image data sets may result in improper identification of the intended thermal treatment, which may lead to patient injury.

- To prevent patient injury, the patient head must be secured with a Head Fixation Device and remain fixed within magnet space for entire imaging portion of the outlined NeuroBlate System workflow.
- If the patient head position changes relative to the head fixation device or the initial MRI position set during the landmark procedure at any point during the NeuroBlate System procedure, new imaging must be acquired and set as the master series or thermal energy may be delivered in an unintended area causing patient injury.
- Every attempt should be made to keep fluids away from the Interface Platform (IP) and Portable Connector Module (PCM) by creating a plastic draping barrier. Fluid contact may interfere with the IP operation or cause failure of the device.
- Fluids must not come in contact with the MR RF coil connections at the head end of the MRI table. A fluid barrier must be placed over the coil connections to prevent patient or operator injury and damage to the MRI system.
- Creating an ablated area that extends beyond the monitored anatomy may exceed the NeuroBlate System's ability to monitor thermal dose, which may lead to patient injury.
- Never pull on the thinner tubular or cable sections of the laser, cooling, temperature sensor, and probe detection lines, as this may damage the components or cause unintended probe movement causing patient injury.
- A non-existent or weak visible laser aiming beam may be an indication of an improperly connected laser fiber. If this condition occurs, do not continue as it may result in equipment damage or injury to patient.
- Ensure there is a clear opening through the skull and dura to allow the Laser Probe to pass without resistance or trajectory deflection. Forcing the probe into the brain when resistance is felt may lead to probe tip fracture and result in patient injury.
- To prevent patient injury, do not mechanically clamp down the laser footswitch during laser energy delivery.
- To avoid equipment damage and patient injury, do not continue to deliver laser energy if no elevation in tissue temperature is observed.
- Failure to allow heated tissue to return to baseline temperature prior to stopping MR acquisition may result in inaccurate calculation of thermal dose levels which may lead to patient injury. Maintain MRI acquisition (which ensures internal probe cooling) while allowing all tissue within the ablation zone to cool to baseline temperature.

As part of the operation of the NeuroBlate System, the user must beware of the strong magnetic field in the MRI room. Extreme caution must be used before bringing in any equipment into the MR environment. Only items identified as:  or  MR Safe as

denoted by the symbol or:  <sup>1.5T/3.0T</sup> MR Conditional as denoted by the symbol can be brought

into the MR room. Any item marked by the symbol:  should not be brought into the MR suite within the 5 Gauss line. Serious injury may result if any equipment which is MR unsafe is brought into the MRI suite.

#### 4.3.1. Electronics Rack Warnings

---

The following are specific warnings that apply to the NeuroBlate Electronics Rack and Electrical Power Inputs.



---

**WARNING:**

---

- Potential hazards may occur from modification of the NeuroBlate System.
- Do not position the Electronics Rack to make it difficult to access electrical outlets or to disconnect the system from the power outlet.

---

### 4.3.2. Robotic Probe Driver and Laser Delivery Probe Warnings

---

The following are specific warnings that apply to the NeuroBlate Robotic Probe Driver (RPD) and Laser Delivery Probe (LDP).



---

**WARNING:**

---

- For single use only. Do not reuse, reprocess or re-sterilize. Reuse, reprocessing or re-sterilization may compromise the structural integrity of the device and/or lead to device failure which in turn may result in patient injury, illness or death. Reuse, reprocessing or re-sterilization may also create a risk of contamination of the device and/or cause patient infection or cross-infection, including, but not limited to, the transmission of infectious disease(s) from one patient to another. Contamination of the device may lead to injury, illness or death of the patient.
- Ensure that probe driver position feedback cable in the vicinity of the MRI bore does not form loops as this may result in heating and RF interference.
- Contact between the probe driver position feedback cable with the inner surface of the MRI bore may result in heating and RF interference.
- The 2.2 and 1.6 mm diameter versions of LDP achieve target accuracy only if a pathway is first created to the target with an appropriate dilator probe such as a biopsy needle, stylet or the Monteris Alignment Mandrel. Consult your Monteris Sales or Clinical Support representative on where to source an appropriately sized Alignment Mandrel.

---

## 4.4. GENERAL CAUTIONS

---

### 4.4.1. NeuroBlate® System

---

**CAUTION:**

---

- Follow the general guidelines for neurosurgery involving the insertion of electrodes, instruments, or devices into the brain or nervous system.
- The user should exercise extreme caution when creating ablation volumes greater than 20 cubic centimeters and consider the potential for post therapy brain edema especially with patients that have limited space within the cranial vault to allow for swelling of the brain. Administration of pre and post therapy steroids should be considered for all patients.
- Follow all MRI safety guidelines concerning the suitability of subjects undergoing MRI procedures.
- System Not User Serviceable: Annual (minimum) specified maintenance and calibration schedules for non-disposable equipment must be performed by trained Monteris representatives. Failure to follow this guideline may result in improper performance and/or damage to the equipment with potential to cause harm.
- Use of controls or adjustments or performance of procedures other than those specified herein may result in hazardous laser radiation exposure.
- Replace damaged equipment. If damage is found, call your Monteris Medical representative.
- Do NOT power ON the Interface Platform during MR imaging. Image quality may be compromised
- Refer to the MRI manufacturer's instructions for use to ensure proper use of hearing protection during operation of the MRI scanner.
- NeuroBlate System should be connected to a power outlet with  $\geq 15$  A circuit breakers. This outlet is to be used by the NeuroBlate system only. Failure to comply may result in power failure during the procedure.
- Do not attempt to re-use single use, disposable patient interface items.
- If unusual software behavior is observed at any given workflow task, the user should exit the Fusion-S application and then re-launch.
- Ensure the PCM and cables (e.g., Position Feedback Plug) are not resting on or in close proximity to the patient during imaging.

- Never pull on the thinner tubular or cable sections of the laser, cooling, temperature sensor and probe detection lines, as this may damage the components.
- Avoid product setups where cabling is taut. This can result in damage or inability to remotely move the probe.
- During treatment near the brain surface, near bone, near large volumes of CSF, or near large blood vessels: There is a risk of damage to adjacent tissues. Careful planning should be done for targets that require treatment adjacent to these tissues.
- During the ablation process the Yellow TDT lines should be kept an appropriate distance (e.g., 1-3 mm) from eloquent structures or functional white matter tracts (i.e., corticospinal tract, optic radiations, arcuate fasciculus, corpus callosum, superior longitudinal fasciculus, etc.). Fusion-S Software supports import of diffusion tensor imaging data which may aid in monitoring of ablated areas near these critical tracts or cortex.
- When choosing the Blue TDT line for monitoring the ablation zone, the user should be aware that there can be a  $\pm 1.5$  mm variance between the actual thermal dose and the Blue TDT line depicted.
- The temperature value indicated from the NeuroBlate laser probe is not an accurate measurement of core body temperature. Do not use this value.

---

#### 4.4.2. Laser Delivery Probes and Robotic Probe Driver

---



**CAUTION:** After use, dispose of product and packaging in accordance with hospital, administrative and/or local government policy.

---

---

#### 4.5. GENERAL SAFETY REQUIREMENTS

---

- The Laser Safety Officer (or employee with appropriate training and authority) must ensure that local safety regulations are observed when the laser is used.
  - The system must only be installed and serviced by Monteris Medical employees or by persons authorized by Monteris Medical.
  - Promptly report accidents and personal injuries to Monteris Medical at 1-866-799-7655 or reporting@monteris.com.
- 

---

#### 4.6. LASER SAFETY

---



**WARNING:**

---

- The NeuroBlate System utilizes a Class 4 laser product in accordance with IEC 60825-1:2014 and IEC 60601-2-22:2019. Irreversible injury may occur. Under no circumstances may the retina of the eye or the skin be subjected to direct or reflected laser radiation.
  - Each person inside the laser area (as described below) must wear protective eyewear. Two sets of protective eyewear are provided with every NeuroBlate System. Contact Monteris Medical for additional protective eyewear.
  - Ensure the laser fiber connections are made correctly. Improper connections may lead to equipment damage or operator injury.
  - Ensure the LDP laser connector is fully seated in the connector receptacle on the IP by gently pulling back on the connector. Failure to do so may cause the receptacle to heat, reduce thermal energy deposition, cause equipment damage and cause operator or patient injury.
  - **Laser Area:** For this laser, the Nominal Ocular Hazard Distance (NOHD) is 2.8 m from the laser output at the LDP tip (when connected) or the extension fiber output on the Interface Platform. Outside of this region, laser safety eyewear is not required.
-



#### 4.7. INSPECTION, CLEANING, DISINFECTION, STERILIZATION

- Germicidal wipes are recommended to remove soil from the Interface Platform Arms and Connector Module. Wipe dry with paper towels. If excessive soiling of surfaces occurs, paper towels can be used dampened with disinfecting detergent to clean. Wipe detergent off using tap water dampened paper towels, followed by dry paper towels.



**WARNING:** Do Not Sterilize! Protect Device from Fluids!  
 Do Not Submerge! Do Not Spray to Clean!

- Prior to Use: Carefully inspect all system laser cable/umbilical connections to ensure they have all completed the “two-click” connection, i.e., plug is pushed into mating connector so that one click at partial (half) insertion and a second click at full insertion.
- Prior to Use: Carefully inspect the Laser Delivery Probe and Robotic Probe Driver packages for any breach of sterile barrier or damage to the contents. **DO NOT USE** if the sterile barrier integrity is compromised or contents appear damaged; contact your Monteris Medical representative for replacement items.



- The Laser Delivery Probe and Robotic Probe Driver are for single use only. Dispose properly after use. See Section 4.3.2 for additional information on reuse



- Do not reprocess or re-sterilize.

#### 4.8. OPERATING CONDITIONS

- Temperature: 15° C (59° F) to 30° C (86° F)
- Relative Humidity: < 70%
- The laser is calibrated to deliver up to 12W (power accuracy of ± 20%) into the laser delivery probe which then delivers this energy through two different emission patterns at the tip based on probe type.

#### 4.9. STORAGE CONDITIONS

- Temperature: 10° C (50° F) to 40° C (104° F)



- Relative Humidity: < 60%
- Keep out of direct sunlight

## 5. MRI Conditional Status



Non-clinical testing has demonstrated the NeuroBlate System Probe Driver, Laser Delivery Probe and Interface Platform are **MR Conditional**. They can be used under the following conditions:

- The Laser Delivery Probe should NOT be moved linearly during any MR imaging acquisition
- The NeuroBlate System is compatible with multiple 1.5 T or 3.0T MRI equipment. Please contact your Monteris Representative for facility specific MRI equipment compatibility or refer to the Instructions for Use Supplement (80575 – Compatible MRI Systems Supplement) at [www.Monteris.com](http://www.Monteris.com)
- Spatial Gradient field of 700 Gauss/cm or less
- Scan only with a maximum whole-body-averaged specific absorption rate (SAR) of 2 W/kg
- Robotic Probe Driver rotary motion can be commanded by the user while the MRI is scanning using the Thermal Sensitive GRE pulse sequence
- Robotic Probe Driver linear motion cannot be commanded by the user via software while the MRI is scanning using the Thermal Sensitive GRE pulse sequence
- Image quality is NOT affected while the interface platform display is OFF
- Image quality may be affected if the interface platform display is powered ON during acquisition, potentially causing image artifacts.
- Probe Driver position is NOT affected by routine clinical RF pulse sequences including Gradient Echo (GRE), Spin Echo, Fast Spin Echo, MPRAGE (a 3D fast GRE scan) and Echo Planar Imaging (EPI)
- No testing has been conducted to demonstrate MR conditional behavior using MR sequences not described above

The following table outlines acceptable operation with respect to NeuroBlate System modes of operation (see section 1.3) and the MRI:

		MRI				
		No Scanning (Idle Mode)	GRE Sequence for Thermometry	Diagnostic Imaging Sequences*		
NeuroBlate	Standby		Allowed	NA	Allowed	
	Active	DICOM File Transfer		NA	Allowed	Allowed
		Probe Cooling		Disabled	Allowed	Disabled
		Probe Travel	Linear	Allowed	Disabled	Not Allowed
			Rotary	Allowed	Allowed	Not Allowed
		Laser Ready		Disabled	Allowed	Disabled
Emergency Stop Engaged		Allowed	Allowed	Allowed		

\* Diagnostic Imaging Sequences tested include Gradient Echo (GRE), Spin Echo, Fast Spin Echo, MPRAGE (a 3D fast GRE scan) and EPI

### 5.1. MR Image Probe Signal Void

The NeuroBlate System family of probes will create an imaging signal void in an MR image. Examples of the signal void are given for an MPRAGE sequence using a 3T Siemens system for each probe diameter (**Error! Reference source not found.5.2**). 3T imaging represents the greatest possibility for exaggeration of actual probe size with a signal void extending approximately 0.3 mm beyond the surface of the probe lens in the example below.

In Figure 5.1 for each probe diameter, the images on the top capture the view of the distal portion of the shaft of the probe, and the images at the bottom are perpendicular to these acquired at the location of the blue line. The left-most top and bottom images show the MR signal void from the probe, and the right-most images have a representation of the probe overlaid on the images for reference.

In order to successfully complete the “Insert” workflow step in a NeuroBlate procedure (see Section 8.7), the current location of probe is identified from the probe signal void in the MR image. The figure below give examples of how the probe signal void may appear and the corresponding probe location as identified from these images.

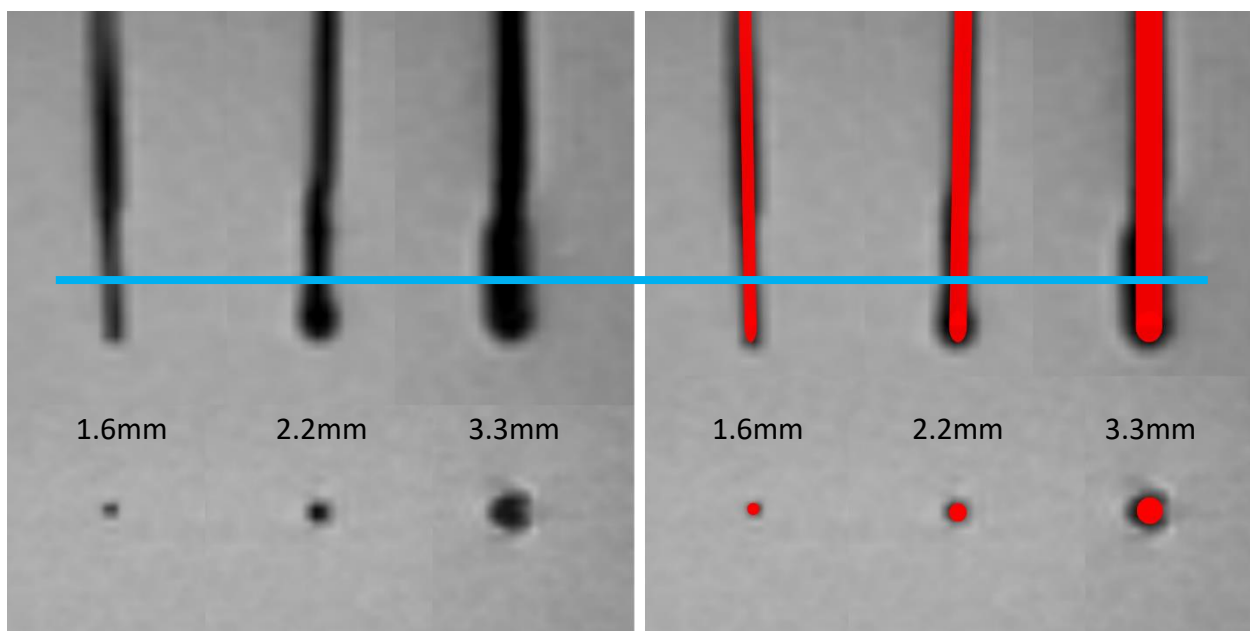

**Figure 5.1:** Parallel (top) and perpendicular (bottom) MPRAGE 3T MR images near the distal end of the probe and a representation of the probe overlaid (right)

## 6. Potential Harms or Hazards

- Perioperative complications for brain surgeries such as MRI-guided neurosurgical ablation may include: sensory, cognitive, or motor deficits; hemorrhage; brain edema/swelling; seizures; general weakness/paralysis; pain; infection (e.g. meningitis or surgical site infection); bone fracture; allergic anaphylactic reaction; cardiac arrest; or death.
- Laser Delivery Probe advancement into, or laser delivery in cerebral vasculature may result in hemorrhage.
- Laser Delivery Probe trajectories which transect critical cortical-spinal tracts or overdosing with thermal energy may result in patient injury and permanent neurological deficits.
- Protracted patient immobilization may cause deep venous thrombosis (DVT).
- Inaccurate Laser Probe delivery to the intended target within the brain may result in hematoma, embolic events, bleeding or unintended major tissue damage.
- Inserting the probe along the trajectory to the target tissue, and/or laser ablation near eloquent brain areas, may result in collateral damage to anatomical structures and related patient complications. Laser Delivery Probe advancement into, or laser ablation in cerebral vasculature or highly vascularized targets (especially in patients with predisposition to bleeding) may result in hemorrhage.
- A malfunction or misuse of the NeuroBlate system may result in a prolonged, incomplete or aborted procedure.

---

## 7. NeuroBlate® System Setup

---

### 7.1. *MRI PROTOCOLS AND DICOM IMAGE TRANSFER SETUP*

---

#### **MRI Sequence Protocols**

It is recommended to create a NeuroBlate specific sequence protocol folder or list on the MR user interface software so the operator can easily identify, load, and execute the required MR acquisitions. It may also be beneficial to include routine radiology pulse sequences for easy access during the case.

Fast 3D spoiled GRE sequences such as FSPGR or MPRAGE can be used for laser delivery probe signal void identification as well as T1/T2 weighted fast spin echo sequences (due to their minimal image signal void in the presence of non-conductive materials). These types of scans should be executed on the MRI only when linear or rotary probe motion is not active.

During system installation, the MRI scanner will be loaded with appropriate Gradient Recalled Echo (GRE) pulse sequence(s) configured to the specifications required by the NeuroBlate System. The following parameters for the given MRI system must be used exclusively for temperature monitoring:

Siemens MRI - 2D FLASH - Standard		Fast (SW v3.18 only)
Name*	AutoLITT (or NeuroBlate) Thermal Seq (GRE)	NeuroBlate Fast Thermal Seq (GRE)
TR	81 ms	48 ms
TE	19.1 ms	8.8 ms
Measurement acquisition time	7.78s	4.6s
Flip Angle	23 deg, recommended [range: 23-30 deg]	18 deg
Number of Averages	1	} Same
Pixel Bandwidth	100 Hz/pixel	
FOV	256x256 mm	
Slice Thickness	5 mm	
Dist Factor (Slice Gap)	5% or 0.25 mm	
Matrix Resolution	128x128	
Phase Partial Fourier	6/8	
Slices per measurement	3	
Number of measurements	512	
Delay between measurements	0.0 s	
Reconstruction	Phase AND Mag	
Fat and Water Suppression	None	
Phase oversampling	0	
Auto Align (VB19 only)	Disabled	
Filter	Prescan Normalize enabled	
Distortion Correction	2D (Unfiltered Images NOT checked)	
Multi-Slice Mode	Interleaved	
Series	Interleaved	
Shim Mode	Standard	
Positioning Mode / Table Position	FIX / H=0mm	

\* Must contain "Thermal Seq (GRE)"

**Note:** The only parameters which can be adjusted are slice position/orientation, phase encode direction and flip angle. When a flip angle range is provided, the lower flip angle can optimize SNR in some tissue types.

<b>GE MRI - 2D FSPGR - Standard</b>		
<b>Details</b>	Series Description*	AutoLITT (or NeuroBlate) Thermal Seq (GRE)
	TR and TE	Automatically set by NeuroBlate system
	Freq. FOV	25.6 (cm)
	Phase FOV	1.00
	Slice Thickness	5.0 (mm)
	Spacing	0.2 (mm)
	Freq. Dir	User Determined
	Acqs Before Pause	0
	# Slices	3
	NEX	0.75
	Bandwidth	6.41 (kHz)
	Flip Angle	13 deg, recommended [range: 13-30 deg]
	Measurement acquisition time	~8.2s
<b>Multi-Phase</b>	Phases per Location	170
	Phase Acquisition Order	Interleaved
	Delay After Acq	Minimum
<b>Acceleration</b>	Phase	1.00
<b>Imaging Options</b>		ASSET, MPh (Multi-Phase), Seq (Sequential)
* Must contain "Thermal Seq (GRE)"		
<b>Note: The only parameters which can be adjusted are slice position/orientation, phase encode direction and flip angle. When a flip angle range is provided, the lower flip angle can optimize SNR in some tissue types.</b>		

Parameters TR and TE cannot be set correctly using the GE MR user interface. These parameter values and others are set automatically just prior to acquisition by the NeuroBlate system via the GE LAIS communication interface using USER\_CV values noted below.

See workflow step: 8.8.1 ENABLE THE MRI FOR REAL TIME TRANSFER.

<b>2D FSPGR Parameter</b>	<b>USER_CV name</b>	<b>Value - Standard</b>	<b>GE MR Version</b>
TE – Echo time	act_te	19100	ALL
TR – Repetition Time	act_tr	27000	ALL
Reconstruction	rhcctrl	29	ALL
Matrix Resolution	rhimsze	128	ALL
ASSET Factor	opphasset_factor	1	V23.X and below only

**WARNING for GE MRI:** To prevent corruption of MRI thermometry data and potential patient injury, use of the ASSET option is required when using compatible receive-only, multi-channel surface coils.

- e.g. as shown below, GE 6-channel Flex Phased Array (left) and 16-channel Flex (right)

---





Philips MRI – FFE	
Scan type	Imaging
Scan Mode	M2D
Technique	FFE
Contrast enhancement	T1
TR	27msec
TE	19.1msec
Flip Angle	13 to 30 deg
NSA	1
Water Fat shift (3T) / BW (Hz)	4.346 pixels / 99.9Hz
Water Fat shift (1.5T) / BW (Hz)	2.175 pixels / 99.9Hz
FOV RL	256mm
FOV AP	192mm
FOV FH	16mm
Acq Matrix	128x96
Slice Thickness	5mm
Slice Gap	0.25mm
Stacks	1
Stacks type	Parallel
Slice Scan Order	Interleaved
Slices	3
Reconstruction Matrix	128
Recon Voxel size	2 mm
Slices per measurement	3
Number of measurements	512 (maximum >10000)
Dyn Scan times	8.2 sec
Fast Next Scan	No
Images	1: M 2: P 3: no
Fat and Water Suppression	None
Phase oversampling	0
Dynamic Stabilization (on 3T)	Enabled
Coil Selection	SENSE-Flex-L
Dual coil	No
CLEAR	No
Shim	Volume
Geometry Correction	Default (2D)

**Summary Panel:**

Total scan duration	26:52.5
Rel. signal level (%)	102
Act. TR/TE (ms)	27/19.1
Dyn. scan time	00:08.2
Time to k0	00:19.8
ACQ matrix M x P	128 x 96
ACQ voxel MPS (mm)	2.00 / 2.00 / 5.00
REC voxel MPS (mm)	2.00 / 2.00 / 5.00
Scan percentage (%)	100
Packages	1
Min. slice gap (mm)	0
Act. WFS (pix) / BW (Hz)	4.298 / 101.0
Min. WFS (pix) / Max. B...	0.165 / 2639.8
Min. TR/TE (ms)	75 / 2.1
SAR / local torso	< 21%
Whole body / level	< 0.2 W/kg / normal
B1rms	0.74 uT
PNS / level	34% / normal
Sound Pressure Level (... 3	

**Note:** The only parameters which can be adjusted are slice position/orientation, phase encode direction and flip angle. When a flip angle range is provided, the lower flip angle can optimize SNR in some tissue types.

With Philips Flex L coils plugged in, use the default “CoilSelection” on Philips R5 systems (Ingenia) normally set with the “Smart Select” feature. This will select both Flex L coils and may also set the Posterior and Q-Body coil as shown below:

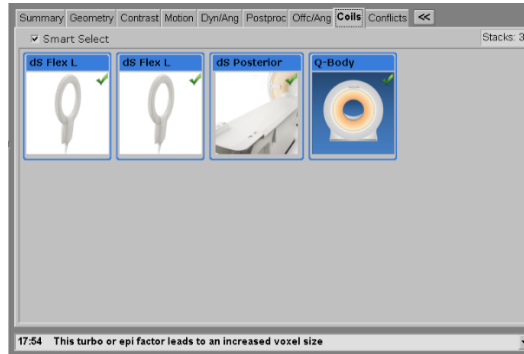

## DICOM Image Transfer Setup



The MRI System should be configured with the NeuroBlate System as a remote DICOM node to allow image data transfer. Consult the MRI System documentation for MRI specific details.

- Siemens Syngo Interface: listed as Monteris in the drop down list of the *Send To* function.
- GE Interface: listed as the Monteris node under the Database function.
- Philips Interface: Two DICOM Nodes are configured. One (having an 'RTT' label) is dedicated for step 1 of the real time transfer process and only for DICOM push of the "header scan". The other is reserved for normal, manual DICOM pushes from MRI to NeuroBlate for planning purposes. This one is typically named MONTERIS.
- Constraints:
  - Localizers or Surveys - these are not needed for NeuroBlate setup and should not be transferred.
  - MRI scan execution should only be done when linear or rotary probe motion is NOT active.
  - Dual Echo sequences - these sequences produce two image data sets within the same series folder (T2 and Proton Density weighted) at identical positions and orientations. If these are used for T2 weighted images, only copy the desired image subset. Currently, the NeuroBlate System software does not handle a full series containing both image types properly.

---

## 7.2. CO<sub>2</sub> TANKS

---



**WARNING:** Medical grade CO<sub>2</sub> size “E” tanks, unless otherwise labeled, are MR UNSAFE and should not be brought into the MR suite within the 5 Gauss line. Use caution when replacing tanks.



**WARNING:** Tank valves must be closed before replacing. Serious operator injury may occur.

---

The NeuroBlate System uses medical grade CO<sub>2</sub> gas coolant for the Laser Probe (Figure 7.2). The Electronics Rack is designed to hold two “E” size tanks. The system user is required to supply the tanks.

### To Replace CO<sub>2</sub> tanks prior to each system use:

- Slide the CO<sub>2</sub> Line Yoke over the Tank Valve and align the two “fingers” protruding from the inside of the Yoke with the two holes on the Tank Valve.
- Tighten the CO<sub>2</sub> Line Yoke T-Handle clockwise using the Tank Valve Wrench attached to the wire tank holders on the Electronics Rack to ensure an airtight connection.
- Again, using the Tank Valve Wrench attached to the wire tank holders on the Electronics Rack, open both CO<sub>2</sub> tank valves (counter-clockwise).
- Ensure pressure gauges for each tank read >4500 kPa (>650 psi).

### CO<sub>2</sub> Tank removal:

- Using the tank valve adapter attached to the rack, close both CO<sub>2</sub> tank valves (clockwise).
- Carefully loosen the CO<sub>2</sub> Line Yoke T-Handle counter-clockwise.



**WARNING:** Tank valves must be closed before replacing otherwise serious operator injury may result!

---

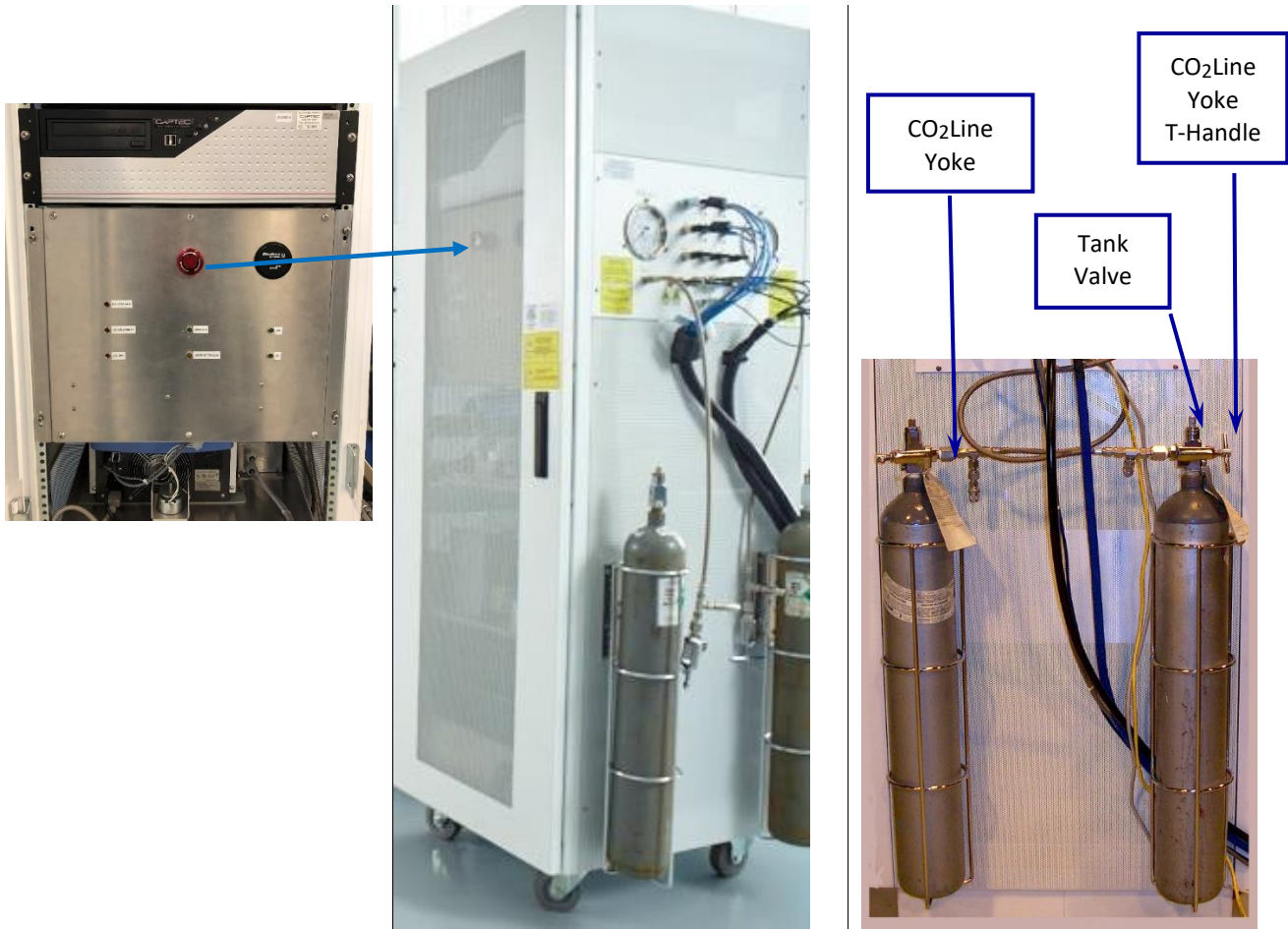

**Figure 7.2 Emergency Stop and Electronics Rack with mounted CO<sub>2</sub>Tanks**

An Emergency Stop switch (see red arrow Figure 7.2) is located inside the door of the Electronics Rack and is intended to disable the system in an emergency. During normal operation, ensure the Emergency Stop switch is not engaged (red light should not be on). To disengage, twist the red button clockwise.

### 7.3. MRI SHIELD PENETRATION FOR NEUROBLATE CABLING

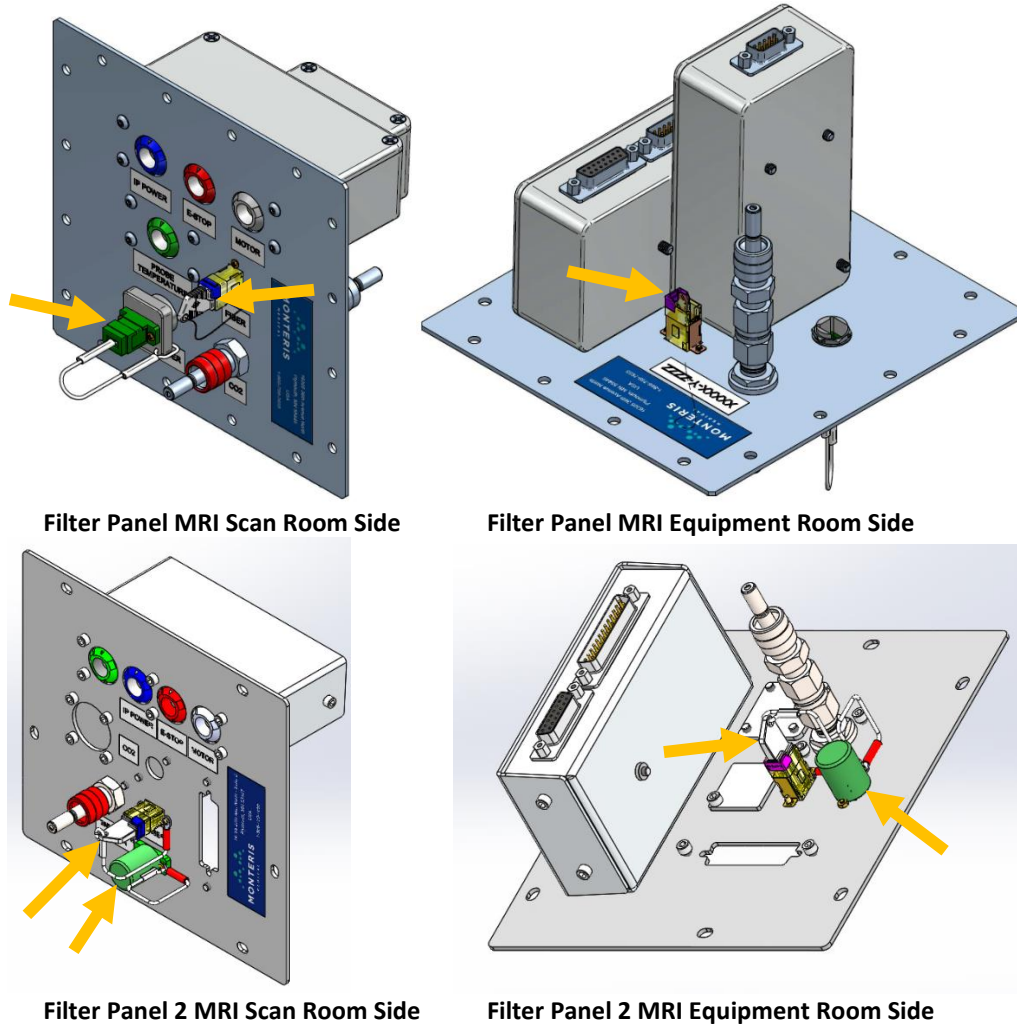

**Figure 7.31 RF Filter Panel and Dust Cover Locations**

The Monteris RF Filter Panel (Figure 7.31) is part of the MRI system penetration panel in the wall between the MR equipment room and scan room. The filter panel allows power and communication to the MRI conditional robotic system which drives the position of the laser delivery probe in the patient’s head. All electrical connections on the filter panel are grounded to the RF shield to prevent conduction of noise into the room.

Typically, the NeuroBlate cabling is left permanently attached on both sides of the filter panel.

- If the installation requires the cables to be disconnected between cases, insert dust covers into the laser fiber and optical temperature sensor connectors when plugs are not inserted (see orange arrows Figure 7.31) and cover the end of the temperature sensor fiber with the protective sleeve.

**Note:** An Emergency Stop switch (image right) is located inside the MRI scan room and connected to the RF filter panel. The stop switch is intended to disable the system in an emergency. During normal operation, ensure the Emergency Stop switch is not engaged (red light should not be on). To disengage, twist the red button clockwise.

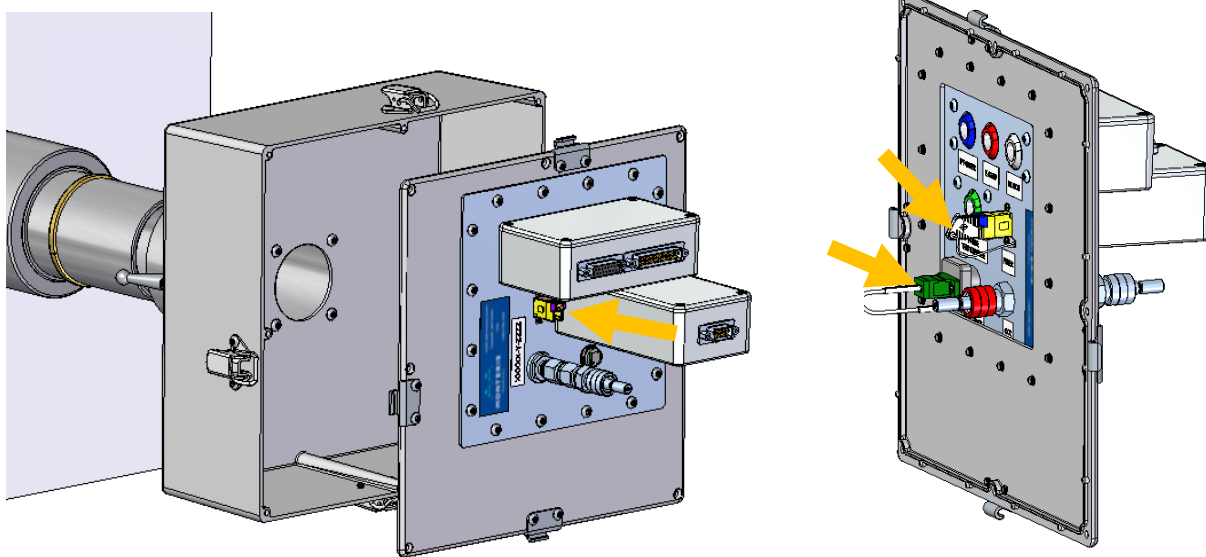

**Figure 7.32 Waveguide Filter Panel Assembly and Dust Cover Locations**

- Insert dust covers into the laser fiber and optical temperature sensor connectors when plugs not inserted (see orange arrows in Figure 7.32) and cover the end of the temperature sensor fiber with the protective sleeve.

#### 7.4. NEUROBLATE SYSTEM CONTROL WORKSTATION:

The Control Workstation is equipped with an Emergency Stop switch (red button) located on the front of the Control Workstation (see Figure 7.4) which is intended to disable the system in an emergency. Check that the E-Stop switch is released (red light should NOT be on). If it is, twist the red knob clockwise to release.

- Turn on the power switch at the side of the Control Workstation (see Figure 7.4) and the monitor will display NeuroBlate System logo launch screen.
- Double-click on the *Fusion-S for NeuroBlate System* icon to launch the software application.



**CAUTION:** The user must perform a *Shut down* under at the *Start* menu of the Windows operating software before using the power switch to power down the system. Failure to do so may result in software failure at restart.



**CAUTION:** Full power shutdown of the system takes 2 minutes. After system shutdown wait 3 minutes to restart power or the system may fail to start up.

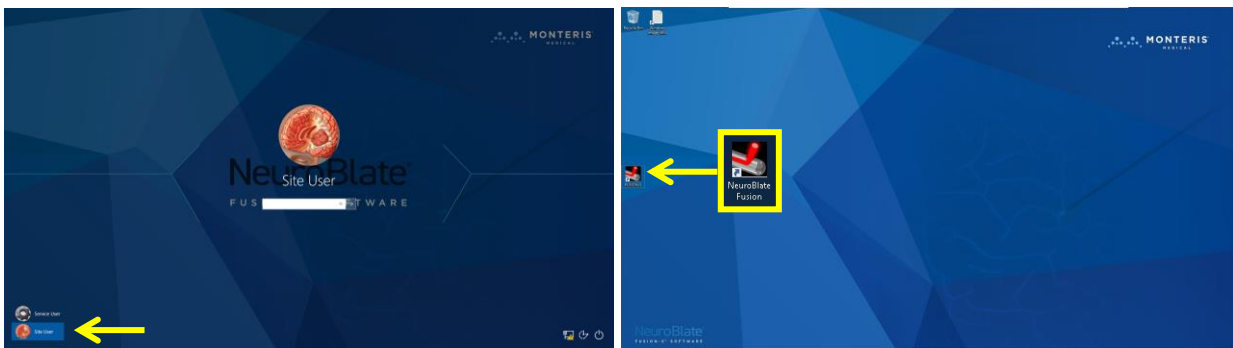

**Figure 7.4: Control Workstation Gen 3 (top); Control Workstation Gen 4 (bottom)**

### 7.4.1. Software Boot Up and Launch Screen

The LCD monitor in the Control Workstation will display the boot up sequence after system power-on. When completed, the login display will appear (Figure 7.4.1 left).

- Click anywhere on the boot-up screen to allow the *Service User* or *Site User* icons to appear
- Click the icon labeled *Site User* (yellow arrow Figure 7.4.1 left)
- Type in the password provided by Monteris Medical
- Confirm workstation PC time and date displayed on lower right side of the display matches the current time and date of the MRI host computer to ensure the timescale of patient data from the MRI is more accurately aligned to events within the NeuroBlate system
  - Contact Monteris Technical Support if changes to the time setting are required
- Double-click the *NeuroBlate Fusion* icon to launch the software application (Figure 7.4.1 right)



**Figure 7.4.1: Boot Up Display (left) and Desktop Display (right)**

**NOTE:** The Fusion-S™ Software must be running before any DICOM data can be sent to the Control Workstation from the MRI.

Upon start up, Fusion-S Software launches in the *Start* task (see Figure 7.51 next page). The default task provides a system diagnostic overview. The user can move between the workflow tasks as noted by the icons in the upper right corner of the screen.



## 7.5. NEUROBLATE FUSION-S™ SOFTWARE APPLICATION

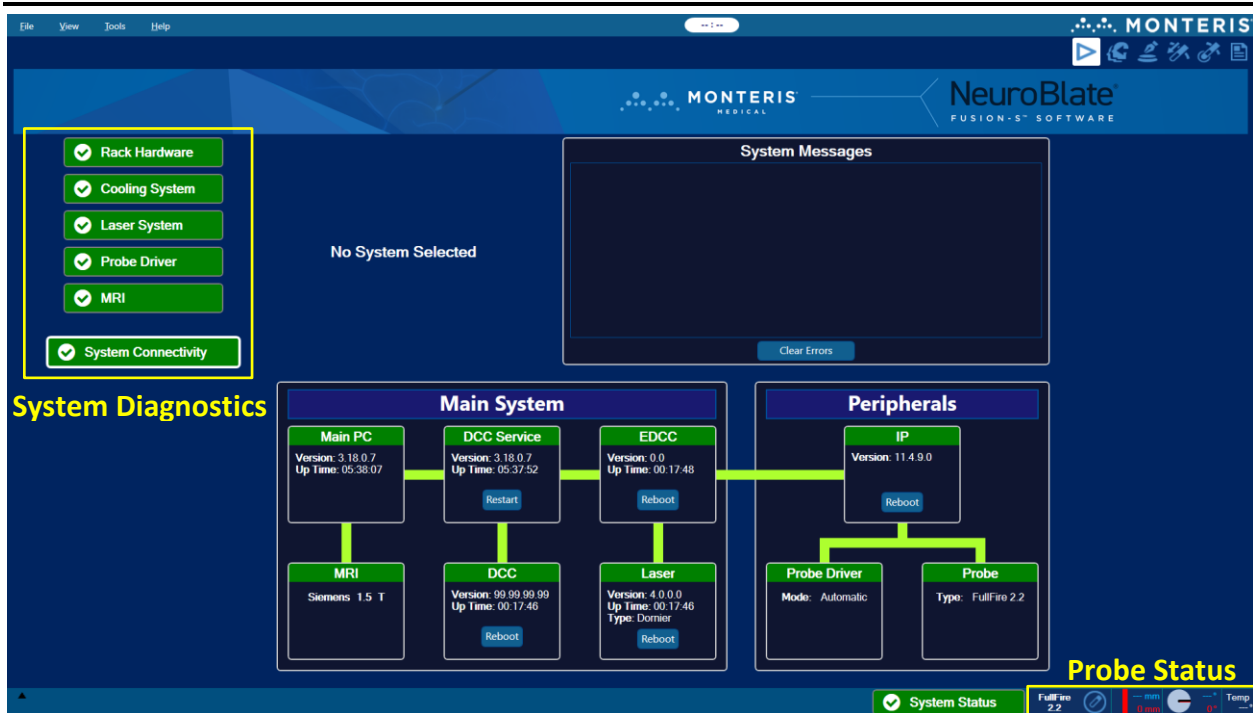

**Figure 7.5: Fusion-S User Interface – Start Task**

NeuroBlate Fusion-S Software provides appropriate tasks, suggests workflows (sequences of actions) and provides appropriate tools to monitor Laser Interstitial Thermal Therapy (LITT). A sample view of the opening screen is shown in 7.5.

Fusion-S provides specific interactions with the NeuroBlate System Hardware, assisting the user in selecting and setting hardware parameters, all while providing key safety controls, data collection, and feedback to the user.

The Probe Status bar in the lower right-hand corner displays the laser probe linear and rotary positions as well as the type of probe that is plugged into the connector module and probe temperature.

The Start screen displays diagnostic indicators for key NeuroBlate systems which are constantly monitored when the system is powered on. Systems displayed with a green status color indicate a normal operating status. Systems displayed in the color red indicate an error condition. Contact a Monteris Clinical or Service Representative in the event of a red indicator. Clicking on any one of the System Diagnostic icons will allow more detail regarding the system operation to be displayed to the right of the icons (see figure 7.5.1).

### 7.5.1. Workflow Task Icons and Description

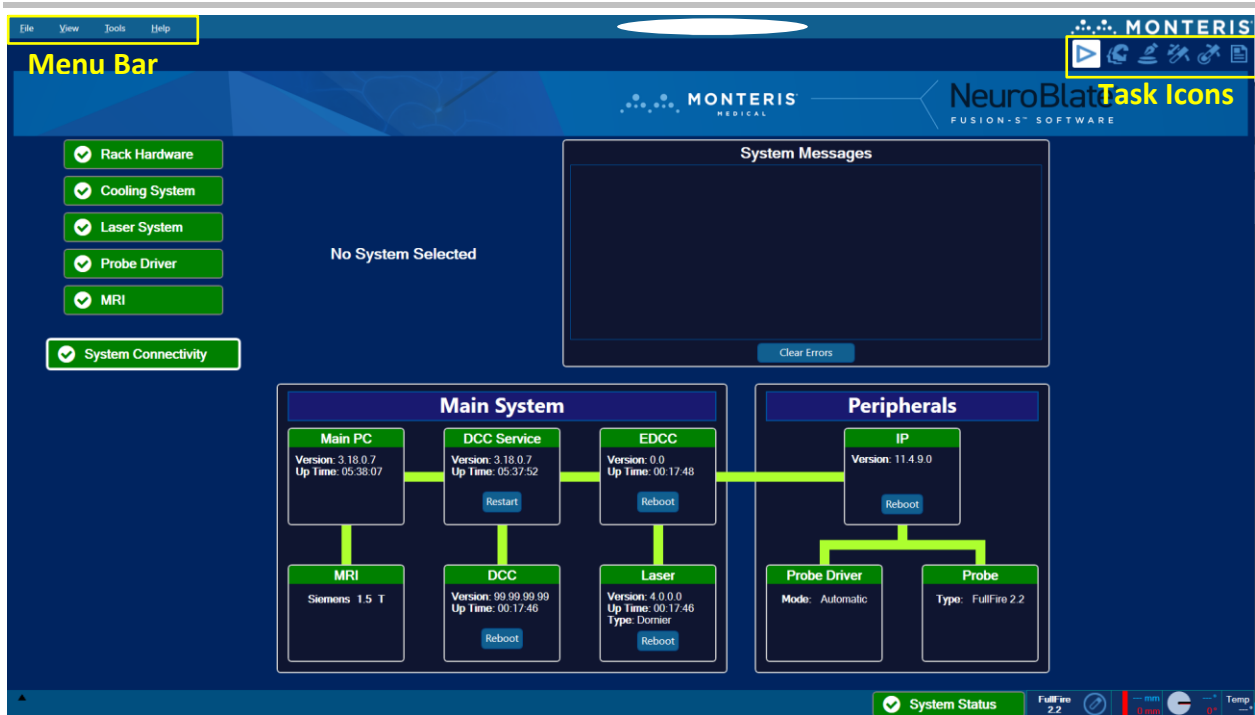

**Figure 7.5.1: Fusion-S Task Icons**

There are six main software task screens represented by icons in the upper right screen including: *Start*, *Registration*, *Volumes*, *Insert*, *Treat* and *Admin* (Figure 7.5.1). Fusion-S constantly saves the active Treatment Profile (the collection of input data, user decisions, instrument conditions and thermal dosing data currently being worked on or executed). However, should the user’s actions result in overwriting existing information or potential injury to the patient (such as firing the laser or moving the LDP within the patient), Fusion-S requires the user to confirm change before proceeding.



**Start** -Diagnostic Dashboard and Robotic vs. Manual Mode for LDP manipulations



**Registration** - Co-register image datasets



**Volumes** - Create user defined volume contours



**Insert** - Define LDP rotary orientation

Match software rendered probe position to laser probe void on MRI image



**Treat** - Thermometry monitoring during laser delivery



**Admin** - Reports procedure details, displays screenshots and allows comment insertion

## 7.5.2. Main Menu Bar Options

**Table 7.5.2: Main Menu Bar Dropdown Menu Options**

<b><u>File</u></b>	<p><b>Open Profile</b> - Load an existing patient plan from a folder</p> <p><b>Import Profile</b> - Import patient Plan/Profile from a hard drive folder in Windows explorer and move to local Plan directory.</p> <p><b>Export Profile</b> - Export a patient Plan to a folder</p> <p><b>Load Images</b> - Load DICOM data (accepts DICOM standard only)</p> <p><b>Exit</b> - Closes the software application</p>
<b><u>View</u></b>	<p><b>Show Navigation Lines</b> - Allows the user to hide the cross-reference navigation lines displayed in the image view panes</p> <p><b>Show Annotations</b> - Allows the user to hide the annotations</p> <p><b>Reset View Settings</b> - Resets the viewport settings to the default setting</p>
<b><u>Tools</u></b>	<p><b>Compare Series</b> - Compares two different image data sets</p> <p><b>Disable DMAX</b> - Allows the user to remove controls which monitor incoming thermal imaging data for RF noise and anatomical motion which will stop laser delivery when detected. When selected the dialogue box (image right) will be displayed requiring the user acknowledge DMAX is disabled.</p>

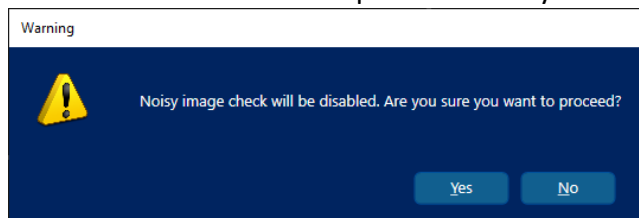

**WARNING:** With DMAX disabled, the software will no longer detect RF Noise nor anatomical motion which may affect the contour lines. Proceed with caution.

### **Help**      **About Fusion-S for NeuroBlate**

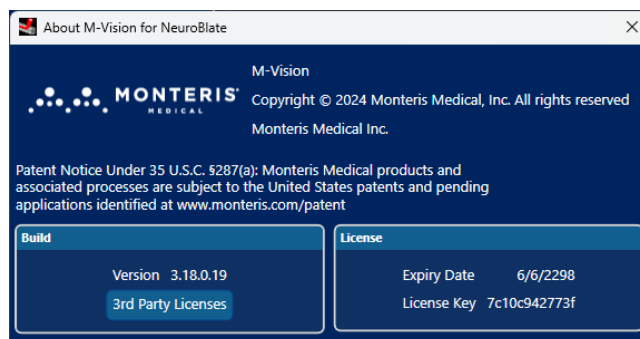

### 7.5.3. Toolbar and System Status Description



**Figure 7.5.3: Main Toolbar**

All Fusion-S workflow tasks with the exception of *Start* use a common toolbar (Figure 7.5.3), found at the upper left side of the software GUI. The Toolbar icons apply to functions used for selection, image manipulation or image adjustment within the image view panes using the left mouse button (unless otherwise noted in table 7.2). Workflow hints are displayed in the right screen menu under the task icons.

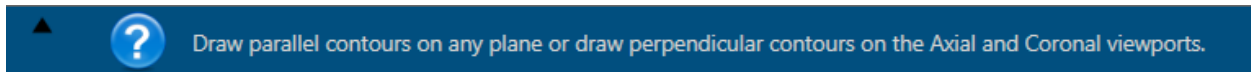

System status information is constantly updated and is displayed on the lower left side of the GUI. Information may include the last step completed, prompts regarding the next step to be performed or system errors. The user should monitor the displayed information.

Error messages that appear should be acknowledged by right clicking on the Status Bar and selecting *Dismiss* in the context menu that appears. If they are not acknowledged they will stay on the status bar indefinitely.

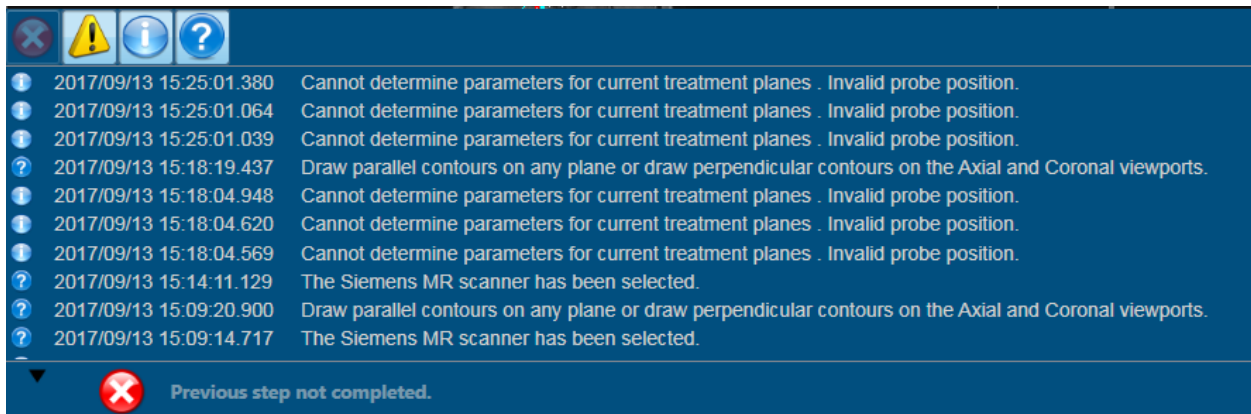

Left click the ▲ symbol to the left of the Status Bar provides a displayed menu of all status updates. Left click ▼ symbol to close the display menu

**Table 7.5.3: Tools Available on Main Toolbar (context sensitive)**

	<b>Default Arrow Tool</b> - used for default manipulation/selection for the GUI
	<b>Window Width/Level (image contrast and brightness)</b> - drag horizontally for width, drag vertically for level
	<b>Drag and drop images between panes</b> - moves images from one image view pan to the next
	<b>Draw and Manipulate Measurement Lines</b> - click and drag to show distance measurements in millimeters
	<b>Magnifying Glass Tool</b> - Displays a magnified area inside the magnification glass wherever mouse is moved
	<b>Zoom All</b> - click and drag vertically to magnify images in all view panes
	<b>Pan images within the viewport</b> - click and hold to change the location of an image within the current view pane (i.e., moving the field of view center in the view pane)
	<b>Zoom</b> - Click and drag vertically to magnify a single image about its center
	<b>Zoom to Region</b> - zoom to display a rectangular area of interest
	<b>Zoom to Point</b> - click and drag vertically to zoom to a specific point on an image
	<b>Add, Edit, Move or Delete Text</b> - controls text box manipulation
	<b>Show/Hide Annotations</b> - displays or hides annotations on the screen
	<b>Show/Hide Crosshair</b> - displays or hides visible crosshairs
	<b>Invert grayscale of all images</b> - converts greyscale to a negative of an image
	<b>Toggle single viewport / multi viewport display</b> - changes from single image display to multiple image display
	<b>Reset All Viewports</b> - changes display settings back to original form
	<b>Save the current screen to file</b> - captures a screenshot of the current display to the saved patient profile

#### 7.5.4. Hardware Interfaces

---

Fusion-S workflow can only proceed if the system is properly configured and connected to the MRI software interface. This will link the target MRI and the NeuroBlate System enabling data communication between the two systems. Patient data in the form of (DICOM) image files must be available on the NeuroBlate System to create a new patient plan. This data is transferred from the MRI to Fusion-S using the standard DICOM send (or push) mechanism on the MRI console. There is **NO** ability to query the target MR system for patient image files and initiate the download from Fusion-S. The NeuroBlate System is configured as a remote DICOM node on the target MRI at the time of installation in order to transfer data from the MR system.

#### 7.5.5. MR Thermal Data Transfer

---

Temperature sensitive MR data is not sent to the NeuroBlate System using the routine DICOM push mechanism from the MRI. A direct technique of automated data transfer with minimal latency must be used. Depending on the MR vendor, an additional LAN connection may be needed between the NeuroBlate System and the MRI internal private LAN in order to receive near real time MRI temperature sensitive data necessary for thermometry calculations.

Only qualified Monteris service personnel should complete these connections and configure the parameters on both the NeuroBlate System and the target MRI (this is part of the system installation procedure).

For some MRI vendors/makes/models, the communication cable may be disconnected between the MRI and the NeuroBlate System. If this is the case, this communication cable needs to be reconnected prior to starting a NeuroBlate procedure and should be disconnected after the NeuroBlate procedure. In scenario's where this cable is connected permanently, no connect/disconnect is needed prior to a procedure.

#### 7.5.6. Initiating Data Transfer Interface

---

For some MRI vendors (i.e., Siemens) in advance of each NeuroBlate System procedure the data transfer interface must be enabled following patient registration on the MRI system. **Note:** The MRI system reverts to the default configuration at the end of the NeuroBlate System procedure when the patient exam is closed on the MRI. Other MRI types do not require any specific instruction prior to the procedure. See workflow step **8.8.1 ENABLE THE MRI FOR REAL TIME TRANSFER.**

### 7.5.7. Thermal Monitoring Slice Planes

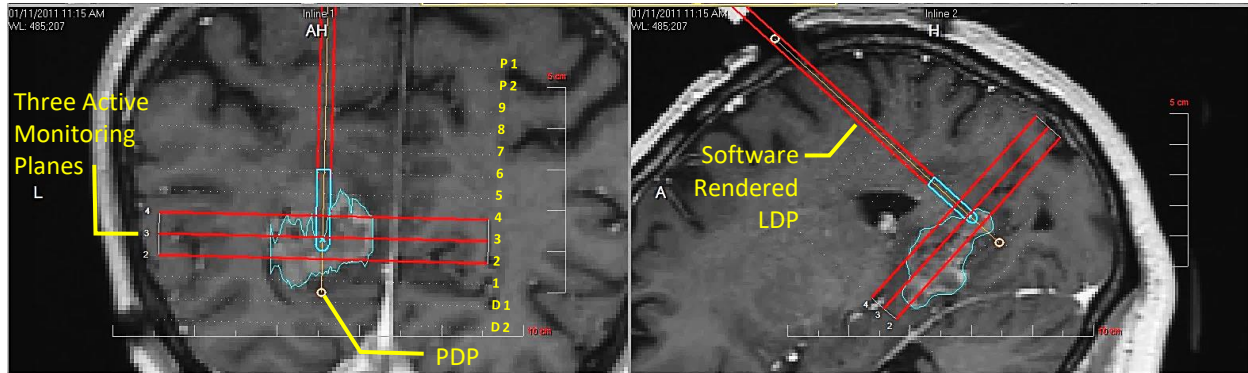

**Figure 7.5.71: Main User Interface Layout**

The NeuroBlate System Fusion-S Software monitors three, 5 mm thick slice planes separated by a 0.25 mm slice gap simultaneously during thermal delivery (Figure 7.5.71). There are 13 slice plane locations available for thermal imaging along the set trajectory which are numbered Distal 2 (D2), Distal 1 (D1), 1 through 9, Proximal 1 (P1), Proximal 2 (P2). The center of each slice plane is described by the parallel white dotted lines above. The slice plane positions are determined by the position of the Probe Deepest Penetration (PDP) in the Fusion-S Insert task.

The three active thermal monitoring planes displayed during the ablation are rendered as solid red lines. The default position for the middle (second) slice is centered ~ 3 mm proximal to tip of the clear probe lens capsule for all laser probe types. The software rendered (laser) probe (SRP) displayed in Fusion-S can be manipulated in either linear direction by 2 mm to rest between the outer and center slice planes based on the user's preference. The planes will automatically adjust the center slice to the default position on the probe with a >2 mm move.



**WARNING:** The ability to monitor ablation progression is limited to a zone that is 15 mm in depth along the axis of the probe separated in three, 5 mm MR acquisition planes and 60 mm in diameter within each acquisition plane perpendicular to the probe and centered at the probe axis intersection of each plane. The 3-plane thermal monitoring slice acquisition should have its midpoint centered at the area of greatest heating as displayed in Fusion-S with the thermal temperature maps. To prevent patient injury, expansion of the thermal ablation beyond these zones must be carefully considered since it is not being actively monitored.

The SideFire probe emits laser energy directionally from a 1 mm laser focal area, the FullFire and NB3 laser probes emit laser energy in all directions (both radial and longitudinal directions).



**WARNING:** Creating a greater than 7.5mm radial ablation area may exceed the NeuroBlate System's ability to monitor thermal dose in the longitudinal direction.

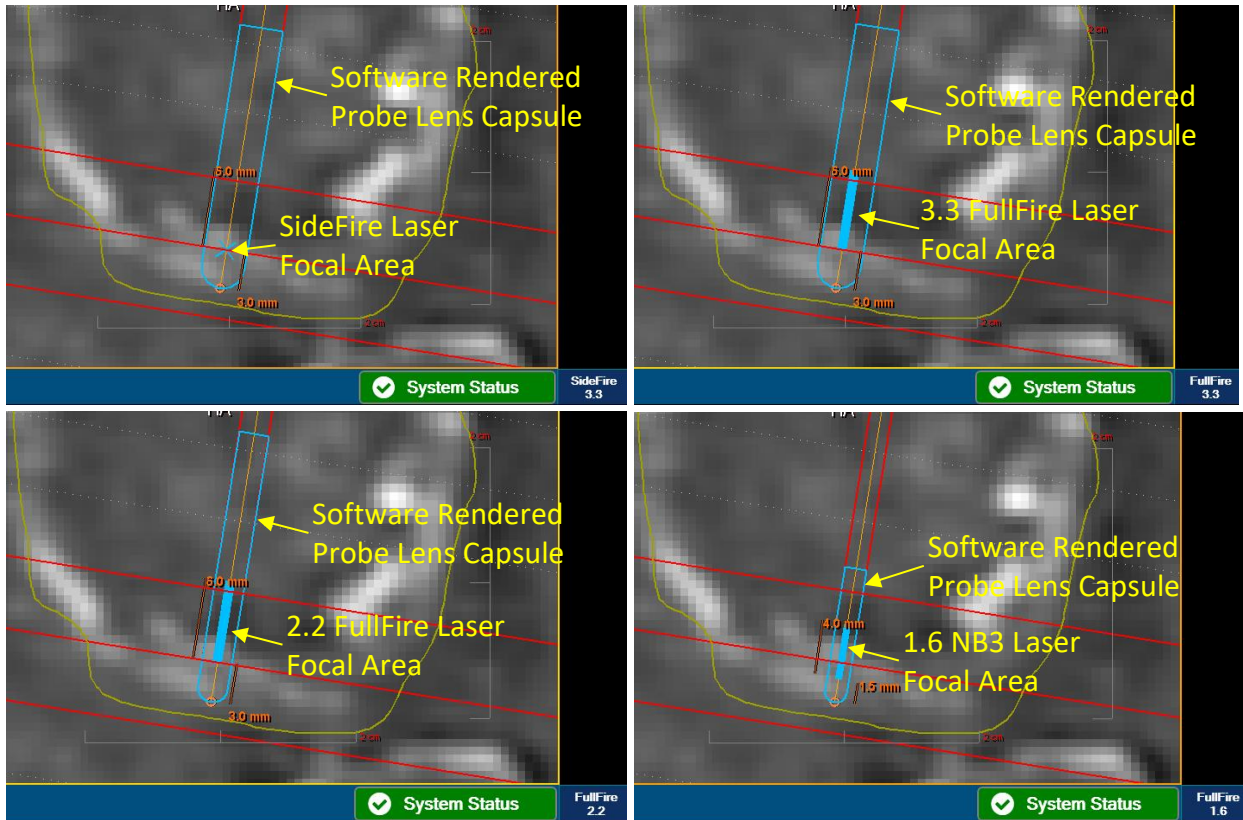

**Figure 7.5.72: SRP Appearance for Each Laser Probe Type and Laser Focal Area**

The software rendered probe’s (SRP) appearance in the Fusion-S software is dependent on the probe that is plugged in. It’s displayed size renders true to scale based on probe type used and the magnification factor of the MRI imaging imported into Fusion-S. It also renders true to scale the appearance of the laser probe’s clear lens capsule (blue end of the software rendered probe) and optical focal (laser energy emission) area’s position and length (Figure 7.5.72).

The 2.2 and 3.3 FullFire LDP have 6 mm long laser focal (laser energy emission) areas which begin 3 mm proximal from the tip of the laser probe lens capsule and is identified by the blue line inside the end of the software rendered probe (Figure 7.5.72). Probe linear position with respect to the three slice planes can be shifted 2 mm proximal or distal to the slice plane’s center before the 3 planes auto adjust to a point 3 mm above the tip of the probe lens capsule.

The 1.6 mm NB3 probe has a 4 mm long laser fiber focal area which begins ~2 mm proximal to the tip of the laser probe lens capsule and is identified by the blue line inside the end of the software rendered probe (Figure 7.5.72). Probe linear position with respect to the three slice planes can be shifted 2 mm proximal or distal to the center of the slice plane before the slice planes auto adjust to a point 3 mm above the tip of the probe lens capsule.



## 8. NeuroBlate® System Procedure Workflow

### 8.1. SYSTEM START-UP AND PROCEDURE PRE-PLANNING

#### 8.1.1. Fusion-S Software Start Screen

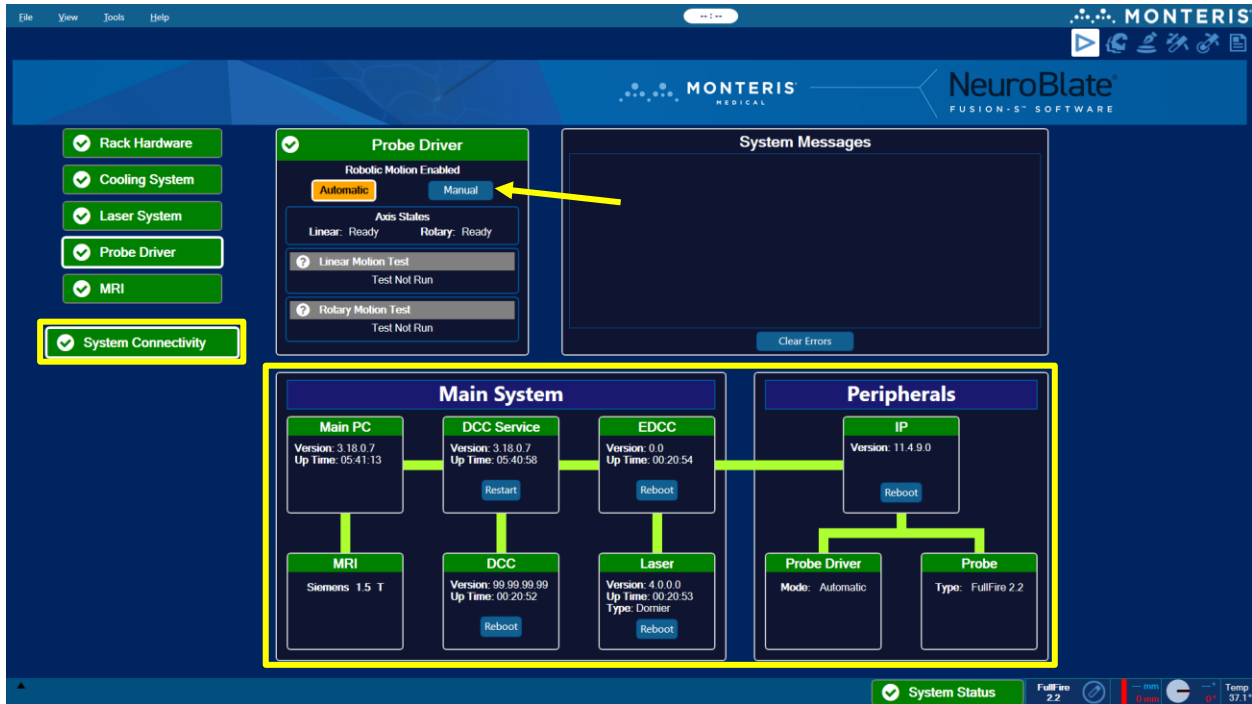

**Figure 8.1.1: Start Task**

On software start-up, the user can select the *System Connectivity* icon to display Main System and Peripheral connection details show at the bottom of the Start Task screen (yellow boxes Figure 8.1.1).

The NeuroBlate System is configured for the host MRI during installation. If the NeuroBlate System is moved to a different host MRI, a Monteris representative must configure the NeuroBlate system for the intended MRI.



**CAUTION:** If unusual software behavior is observed at any given workflow task, the user should exit the treatment profile, exit the Fusion-S application and then re-launch.

If the workflow involves the use of a trajectory platform without the Probe Driver, select the *Probe Driver* diagnostic button and click the *Manual* button in the *Probe Driver* diagnostics menu (yellow arrow Figure 8.1.1) Default selection assumes use of the Robotic Probe Driver.



Proceed to the next desired workflow task by selecting the appropriate task icon on the upper right side of the GUI.

On the day of the procedure and upon start-up of the Fusion-S Software (see Figures 7.4 and 7.4.1), the system diagnostics at the *Start* task should be used to run *Test Tank Pressure Test* and *Laser FootPedal Test*.

- Ensure the CO<sub>2</sub> tanks have been completely opened at the Equipment Rack
- Select the *Cooling System* button and click the *Run Tank Pressure Test* icon  
- After the test is successful, the display should now appear as shown (image above right)
- Select the *Laser System* button and click the *Run Foot Pedal Test* button
- Depress the laser foot pedal attached to the Control Workstation for 3 sec and release  
- At successful completion, the display should look similar to the image to the right

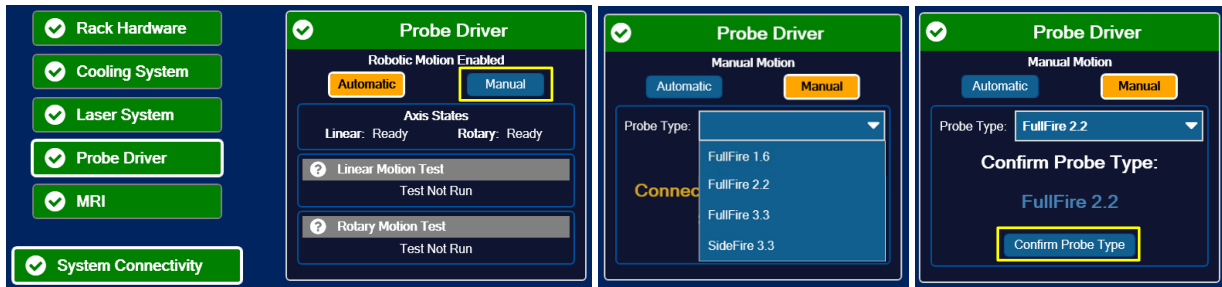
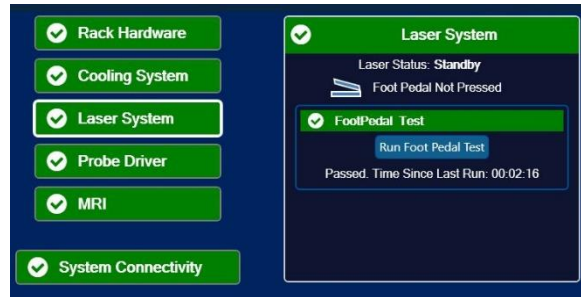
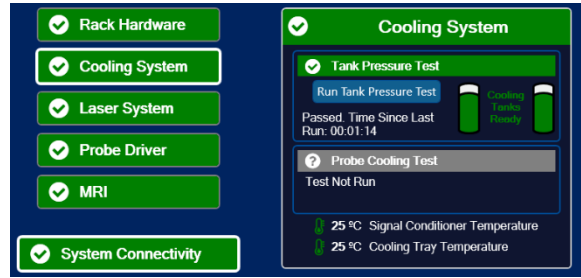

If the workflow involves the use of a trajectory platform without the Probe Driver, select the *Probe Driver* diagnostic icon and click the *Manual* button in the *Probe Driver* diagnostics menu (yellow box image above left). Default selection assumes use of the Robotic Probe Driver.

- The intended Probe Type used must be selected from the dropdown (image above middle)
- Confirm that the selected probe type is the probe type that is plugged into the system and select *Confirm Probe Type* (yellow box image above right)
- The display will change to *Probe Type Confirmed* and the selected probe type will now be displayed under Peripherals and in the lower most right side of screen next to the System Status icon

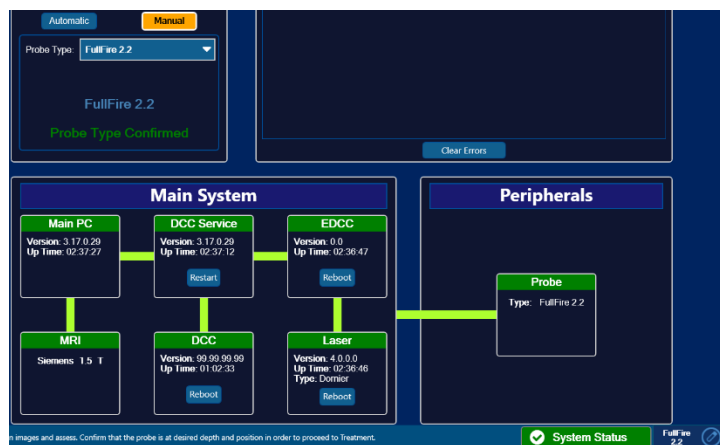

### 8.1.2. Load and Register Image Data within *Registration* Task

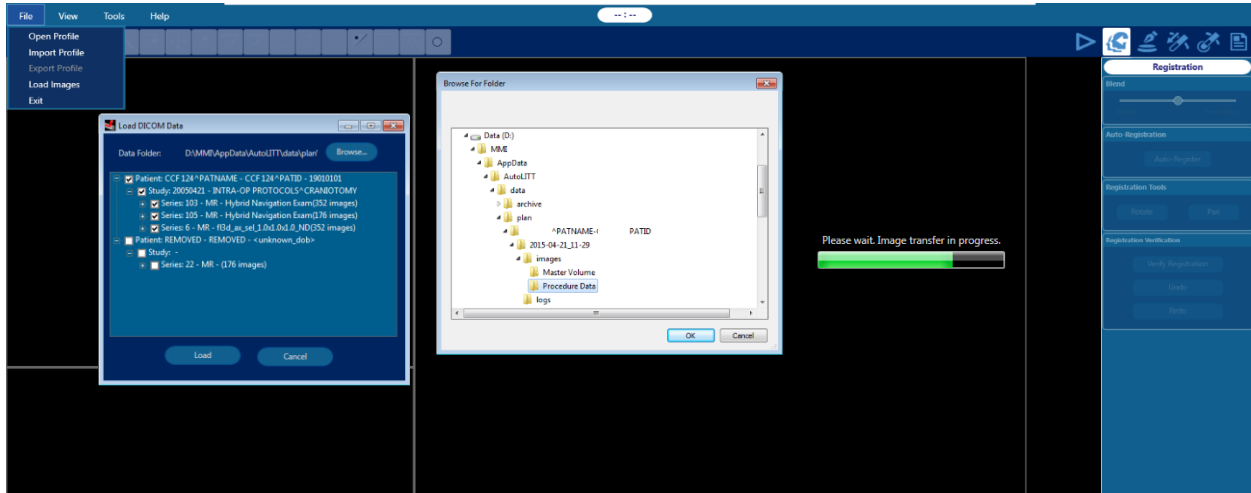

**Figure 8.1.21: Loading DICOM Data in *Registration* Task**

The *Registration* task allows image data pushed from the host MRI scanner to be received or loaded from USB drive. In this task, loaded images can be manually or anatomically co-registered.

The user can also load DICOM data such as pre-op imaging from a USB drive using the following steps:

**Note:** The user must ensure that any removable device (e.g., USB drive) or CD/DVD media be free of computer viruses or malware before connecting to the system:

- Select the *FILE* menu > *Load Images* (DICOM standard format only)
- Once the *Load DICOM* Data box appears on the screen, select *Browse* and navigate to the desired USB drive to load a DICOM dataset
- Use Windows Explorer *Browse For Folder* menu to find the desired data folder to load
  - Click the desired data folder and click *OK*
  - The data will automatically load to the Fusion-S Software

Previously planned or completed cases, called Treatment Profiles, can also be opened:

- Select the *FILE* menu > *Open Profile*.
- select *Browse* and navigate to the desired USB drive to load a DICOM dataset

Note: If a dataset is loaded which does not match the patient data of previously loaded datasets, the error message shown to the right will appear.

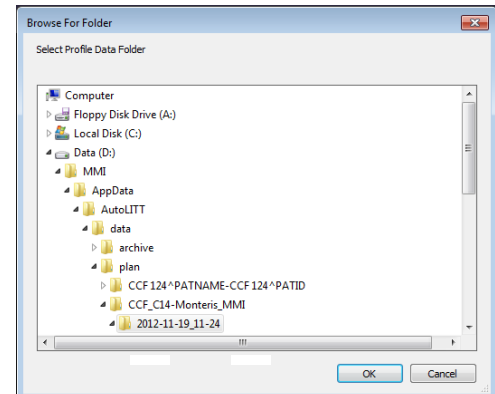

If multiple image datasets are loaded, all sets used for planning must be registered and verified to a Master Data Set (default will always be the first image dataset loaded). Any of the image sets loaded in *Registration* can be designated as the Master series by right clicking on the corresponding image thumbnail views to the right of the image view panes and selecting *Set As Master*. Any data set can be erased from the software by right clicking on the image thumbnail and selecting *Clear*.

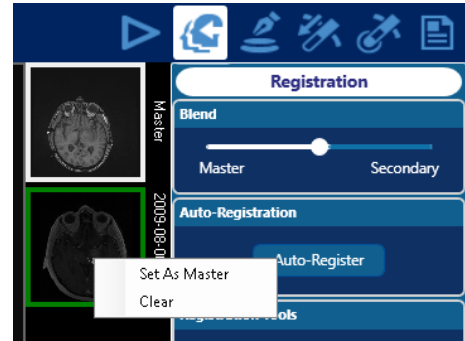

 **CAUTION:** If all images are cleared the user should close the treatment profile, exit the Fusion application and then re-launch.

If the incoming images do not appear oriented correctly the views may be rotated using the View Plane Rotation tool.

The View Plane Rotation tool enables a 3-dimensional rotation to correct the views to match the desired orientation. The View Plane Rotation tool rotates all 3 views together and maintains the relative orientations between the views. After selecting the View Plane Rotation tool, click a single view and drag around the clicked point to rotate the selected view. When the mouse is released, the other two views are re-aligned to match the vertical and horizontal axes of the rotated view.

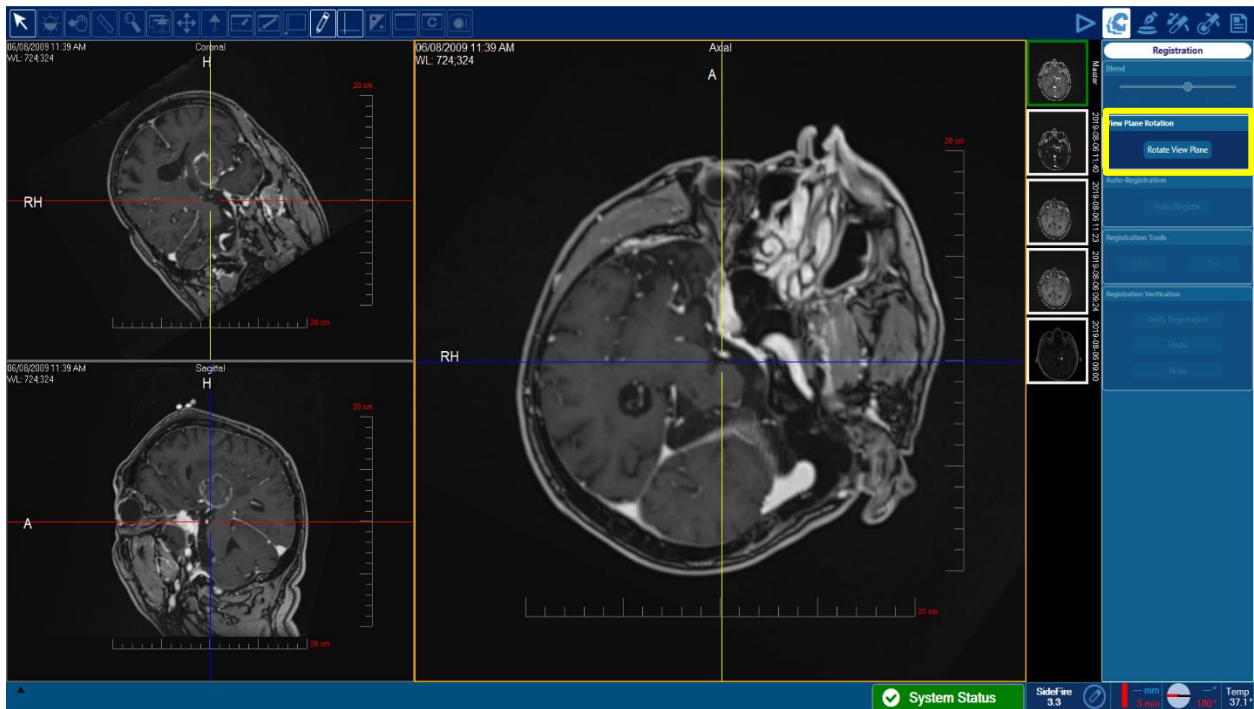

**Figure 8.1.22: View Plane Rotation in Registration Task**

The rotation changes are saved as the “Default View Settings” and the Reset View Settings functionality will now reset back to the updated orientations. This allows for resetting the pan, zoom, and window level without affecting the rotation.

The View Plane Rotation tool affects the Master series. If the tool is used on a verified registered secondary series, the Master series is rotated along with the secondary series. To avoid unintentional rotations of the Master series, this functionality is only allowed on series that have been verified as registered to the Master series.

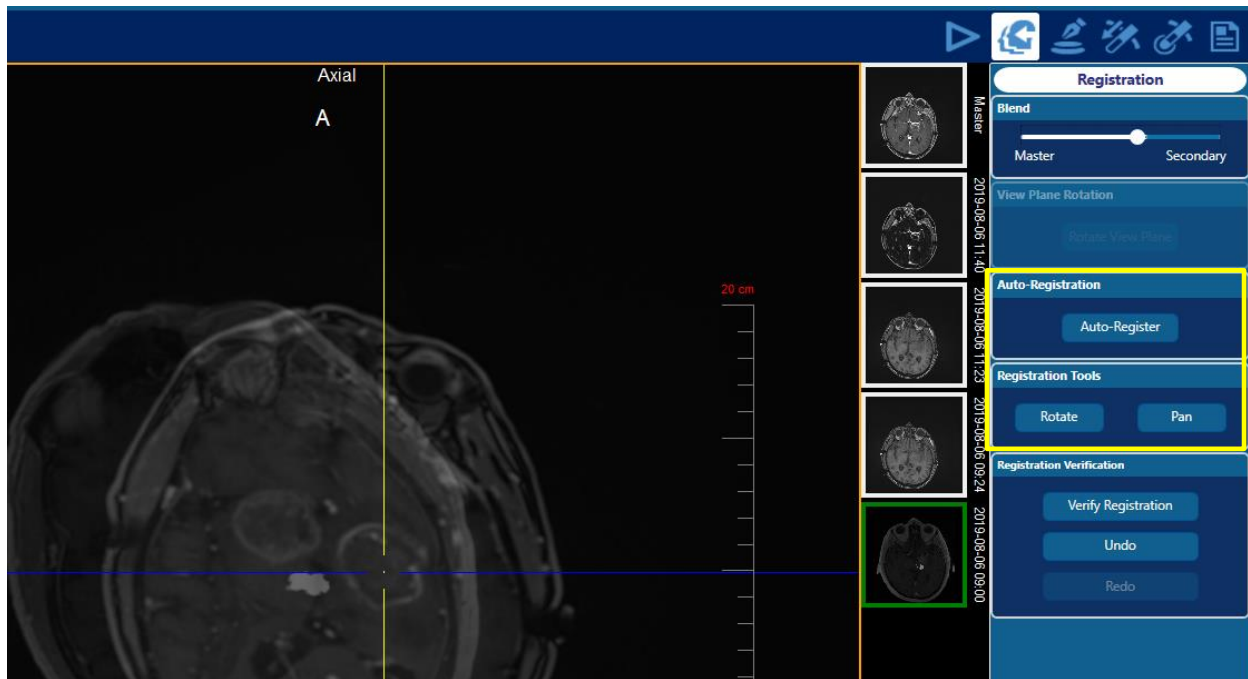
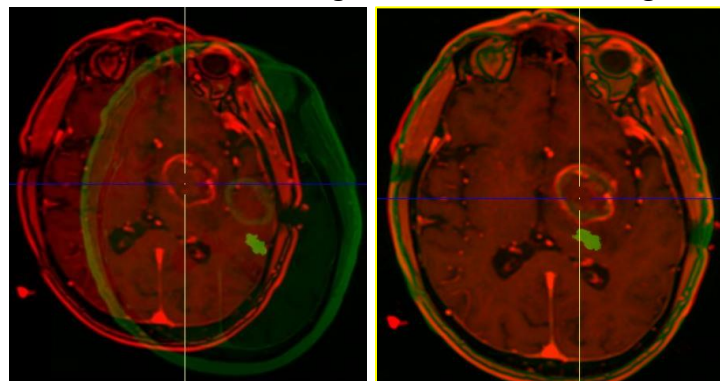

**Figure 8.1.23: Image Co-Registration in Registration Task**

- Click a thumbnail view to the right side of the image view panes for the desired image dataset to be registered (highlighted green in Figure 8.1.23)
- Select *Auto-Register* from the menu and the software will attempt to register a “best fit” of the two anatomical data sets, based on pre-determined thresholds within the anatomy

If the automatic registration seems inaccurate or if manual registration is desired as a starting point prior to Auto-Register, use the *Rotate or Pan* icons under *Registration Tools* in the right menu to adjust the secondary image over the Master.

**Note:** Once the Rotate or Pan icon is selected the master image will be colored red and the secondary image will be colored green (image right). When images have been aligned, they appear in a yellow hue as shown in the image to the far right.



- Use the *Rotate* button to rotate the secondary image around its center
- The *Pan* button allows the secondary image to translate to the desired location.
- While in manual registration mode, the shift key can be used to switch from *Pan* and *Rotate* mode quickly while editing. If the *Rotate* button is selected on right, holding Shift key applies *Pan* function and vice versa.
- The *Undo* button to clear any Pan, Rotate or Auto-Registration action previously completed.



**Figure 8.1.24: Using the *Blend* tool to assess registration accuracy**

- Use the *Blend* slider bar in the right menu bar to blend the imported data set into or out of the Master series (yellow box Figure 8.1.24)

This tool is to be used to verify the registration accuracy of each image set registered to the Master. The blend function is disabled while in manual registration mode.

- Once an imported image set is registered appropriately to the Master series, the *Verify Registration* icon must be selected
- Prior to proceeding to the next workflow step, the user shall visually inspect alignment to master of ALL previously loaded secondary series, NOT ONLY the last one verified
- If any misalignment is observed with any secondary series to the master, the user must remove any incorrectly aligned secondary series of same study



**WARNING:** Extreme care should be exercised during visual verification of image registration. If an image series cannot be accurately registered to the Master series, it should be deleted before proceeding to treatment planning or thermal monitoring. Inaccurately registered image data sets may result in improper identification of the intended thermal treatment area, which may lead to patient injury.

### 8.1.3. Create Region of Interest (ROI) Volumes within the *Volumes* Task



**Figure 8.1.31: Create an ROI Volume in *Volumes* task**

The *Volumes* task allows the user to outline up to ten regions of interest (ROI) volume contour annotations within the data set in different (pre-set) colors. A volume contour can be defined using software tools within the Fusion-S Software as described in the following pages. The user should consider outlining the intended ablation area to use as a guide during thermal delivery but this task is not required to move forward to ablation.

There are three contouring algorithms to choose from (the first two contain a smart brush feature - lines snap to borders)

**General** - used for less-complicated, spherical structures

**Irregular** - used for complicated, non-spherical structures

**Freehand** - left click-drag to trace around structure using the Arrow Tool

- Select the desired contouring algorithm under *Input Contours*
- Left click and hold while dragging the Arrow Tool across the intended structure from margin to the opposite margin in a diagonal manner on each of the reconstructed orthogonal views on the left (white arrow tool shown in Figure 8.1.31)
- Select *Generate* to create the 3D volume contour



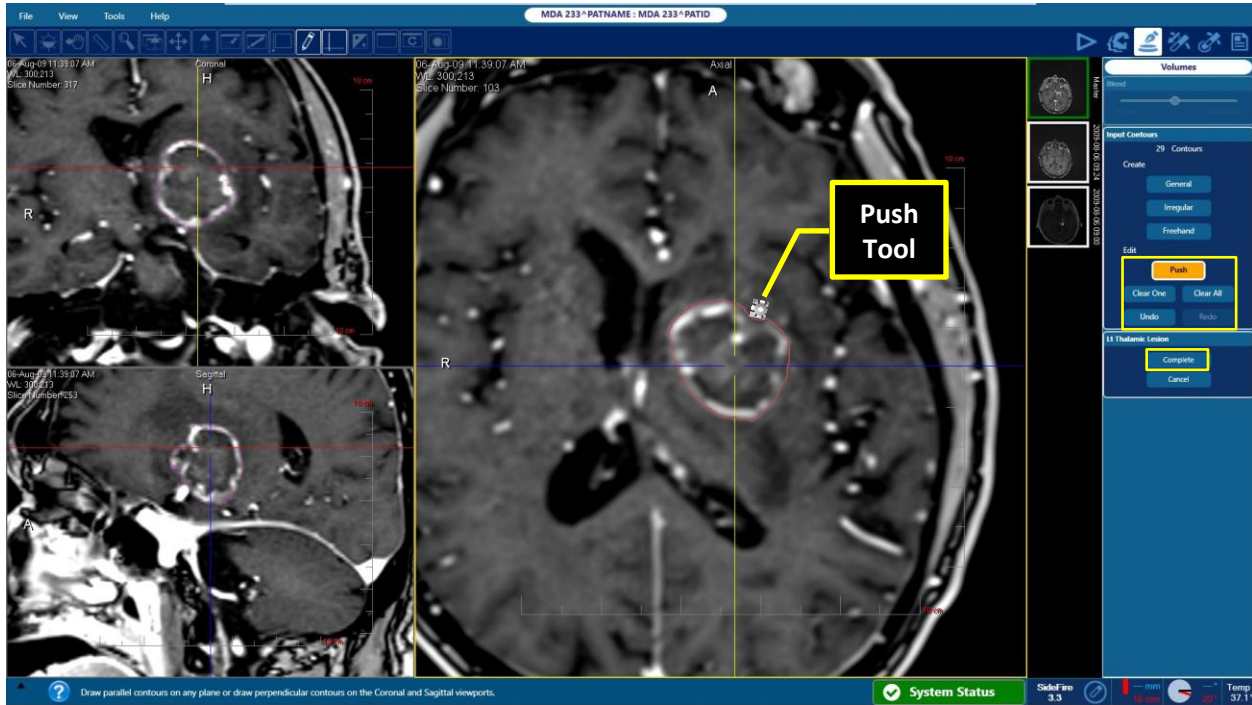

**Figure 8.1.32: Edit the Generated Volume Contour**

Once the volume is generated the created contours can be edited in the acquisition plane (right side view pane only):

- Select the *Push* icon under *Edit* to change created contours with the *Push Tool*
- Use the Push Tool (Figure 8.1.32) to adjust the boundaries of the initially defined contour - left click and hold while touching the boundaries of the contour with the Push Tool
- Use the scroll wheel on the mouse to move from image to image in the acquisition plane and continue to edit each slice as needed

**Note:** The size of the push tool can be changed by holding the left mouse button and using the Page Up and Page Down buttons, or by scrolling the middle mouse wheel to allow larger or smaller manipulations.

**Note:** All contour lines can be removed by selecting *Clear*.

**Note:** A single slice contour can be removed by selecting *Clear One*

**Note:** If part of the intended structure is not outlined on any given slice, a new contour can be drawn around the structure using any of the three contouring algorithms under *Create*.

**Note:** The Push Tool can also be used when creating the initial two outlines.

- Select *Complete* when desired slices have been edited
- To create additional contour volumes for anatomical structures or safety zones, follow the same steps to select the Interactive Tool, followed by the Push Tool



### 8.1.4. Saving a Plan

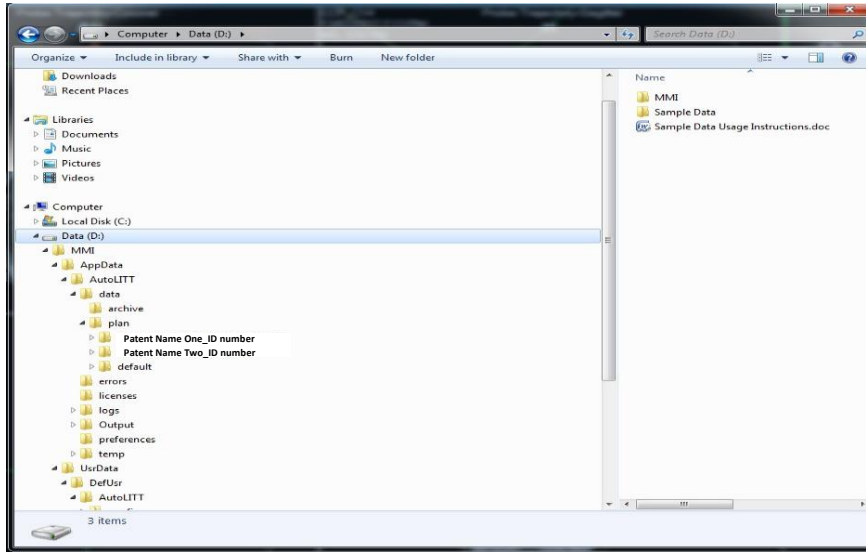

**Figure 8.1.4: Plan Saving Hierarchy**

Fusion-S Software continuously saves all treatment planning profiles. If the system shuts down or is turned off during the planning phases, the plan profile will be saved using the patient name embedded within the DICOM image data loaded into the system during planning. Figure 8.1.4 illustrates how to determine the name given to the plan, as well where the data will be stored when it is saved. The plan profile can be located using Windows Explorer under *D:\MMI\AppData\AutoLITT\data\archive\plan* folder. Within this folder, a subfolder is first defined by the *patient name-patient ID number*. Within this patient folder is a subfolder having a date-time string (YYYY-MM-DD\_HH-MM) defining the specific plan profile for the patient.

### 8.1.5. Opening a Saved Plan



**Figure 8.1.51: File Menu To Open a Plan**

If a plan has been created and saved prior to treatment, this data can be loaded into Fusion-S Software using the following steps:

- Select the *File* menu in the top menu bar of the software.
- Select *Open Profile* from the drop down bar under the *File* menu (see Figure 8.1.51).

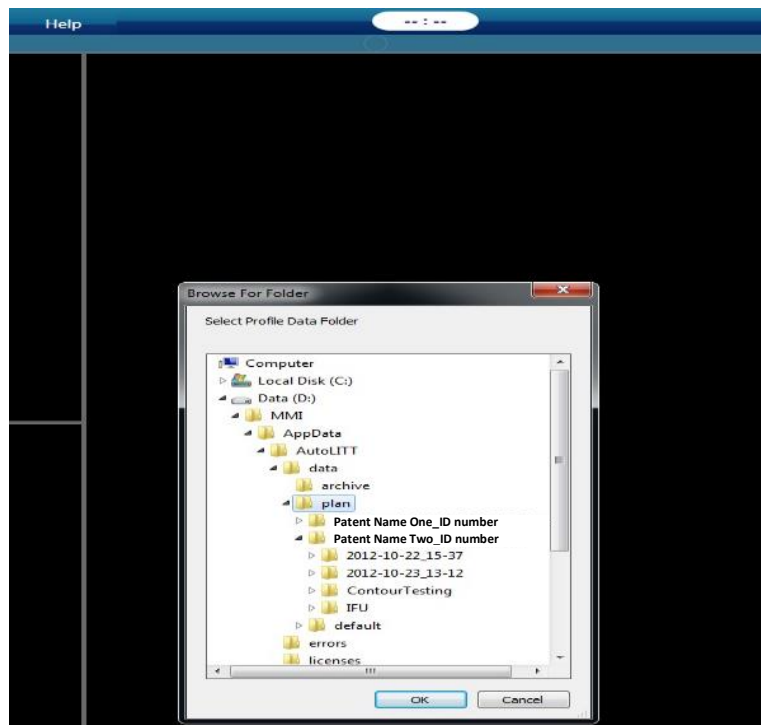

**Figure 8.1.52: Finding the Saved Plan**

- Browse the open Explorer window which points to the “plan” folder within the system.
- Select the saved plan by clicking the patient name followed by the correct treatment profile number defined by the date/time string (see Figure 8.1.52).

**Note:** Plans can be opened if stored on USB drive by using the *Import Profile* selection under *File* and then following the same steps detailed above. USB data will now be in the plan folder.

- Once the patient data is selected, the plan is loaded in *Registration*.

---

## 8.2. OPERATING ROOM: PRE-PROCEDURE PREPARATION

---

### 8.2.1. Sterile Probe Delivery Platform

---

Each of the laser delivery probe (LDP) shall be handled in a sterile field; various delivery platforms are suitable with options to allow probes to be mounted with or without an RPD. The appropriate skull anchoring device and RPD should all be sterile and MRI safe.

### 8.2.2. Anesthesia

---

The patient may be placed under general anesthesia following standard hospital procedure. During, or immediately following anesthesia administration, the following should be verified:

- A medically tested and MR compatible temperature probe should be inserted into the nasopharynx of the patient for accurate temperature readings throughout the procedure;
- Ensure patient has ear plugs in both ears in preparation for MRI scanning.

### 8.2.3. Head Fixation

---

The patient's head must be fixated with an appropriate Stabilization System and MRI imaging coil.

Refer to Instructions for Use for the MRI RF coil and fixation system used.



**WARNING:** The patient head must be secured with a Head Fixation Device and remain fixed within magnet space for entire imaging portion of the outlined NeuroBlate System workflow.



**WARNING:** If the patient head position changes relative to the head fixation device or the initial MRI position set during the landmark procedure at any point during the NeuroBlate System procedure, new imaging must be acquired and set as the master series or thermal energy may be delivered in an unintended area causing patient injury.

---

### 8.2.4. Image-Guided Surgery (IGS) System Registration (Non-Sterile)

---



Follow Instructions for Use of the Image Guided Navigation System selected to perform Registration of image space to physical space based off pre-operative imaging.

- Use the IGS system to define an entry point on the anatomy as well as the planned incision.
- Perform visual and manual checks to ensure the desired MR RF coil will fit appropriately about the head with respect to the intended attachment of the selected position of the laser probe delivery platform.

### **8.2.5. Prepping and Sterile Draping for Trajectory Guidance Devices**

---

Depending on the trajectory device used to guide the laser delivery probe to target, please refer to the specific Instruction for use included with each device for preparation and sterile draping procedures.

Refer to manufacturer’s Instructions for Use included with the selected intended laser probe delivery platform.

### **8.2.6. Image-Guided Surgery (IGS) Registration - Sterile**

---

The image-guided navigation system registration task is performed using sterile technique based on pre-operative imaging.

Once the IGS system is accurately registered, the previously identified entry point and incision plan is confirmed.

### **8.2.7. Laser Delivery Probe (LDP) Platform Attachment**

---



Follow Instructions for Use to attach the selected LDP Delivery Platform to the skull.

#### **8.2.7.1. Skull-Mounted Trajectory Devices**

---

- Attach the device at or about the desired entry location on the skull
- Align the device to the intended trajectory
- Trephine the skull along the desired trajectory using a 4.5 mm twist drill bit for the legacy probes and a 3.2 mm bit for the 1.6 NB3

#### **8.2.7.2. Skull Bone Anchor such as Monteris Mini-Bolt**

---

Skull bone anchors appropriate for delivery of the NeuroBlate laser delivery probes must be manufactured from materials that are MRI conditional at 1.5 T and/or 3.0 T. The internal diameter of the anchor must accommodate selected laser probe diameter (1.6 mm, 2.2 mm or 3.3 mm). The outer diameter cannot exceed 7.95 mm for attachment of the Robotic Probe Driver.

- Drill an appropriately sized twist drill hole at the desired entry location on the skull along the intended trajectory
- Fix the bone anchor within the created twist drill hole along the intended trajectory

### 8.2.8. Create a Pathway to the Intended Target

- Use standard surgical technique to open the Dura to ensure clear passage for the laser probe into the brain
- Insert an appropriately sized, rigid probe such as a biopsy needle, stylet or the Monteris Alignment Mandrel through the delivery platform to ensure proper clearance for the LDP through skull and Dura (image right)
- It may be desired to insert a rigid probe or stylet all the way to the intended probe deepest penetration (PDP) point to open a pathway for the LDP through tissue into the target area
  - This step is optional for the standard 3.3 mm diameter LDP unless the intended target is a tissue type that is difficult to penetrate. Consideration should be given to the density of the intended ablation target
  - This step is required for the 2.2 and 1.6 mm laser probes to ensure accurate placement along the intended trajectory



If using the Alignment Mandrel provided by Monteris, note that one end of the mandrel has a blunted tip and the other has a sharp tip (see image below).



**Note For the 1.6 Laser Probe:** it is recommended to do this step immediately prior to laser probe insertion in the MRI suite. Contact your local Monteris Clinical Specialist to source single-packed, sterile 1.6 mm Alignment Mandrels

- Depth from the proximal end of the skull bone anchor to the PDP should be assessed using image-guided navigation or via the surgical planning software to mark a stopping point or set a depth stop on the shaft of the rigid probe



**WARNING:** The 2.2 and 1.6 mm laser probes achieve target accuracy only if the pathway is first created to the target with a rigid probe, stylet or Monteris Alignment Mandrel.

- Remove the rigid probe from the delivery platform prior to transporting the patient to the MRI
- Create a sterile field around the delivery platform using off the shelf draping for transport to the MRI

### 8.2.9. Laser Delivery Probe (LDP) Length and Depth Stop Setting

The correct LDP length and depth stop setting can be determined in the operating room prior to the procedure by utilizing the point of deepest penetration (PDP) as defined using stereotactic navigation. The measurement methods described below assume the skull bone anchor is fully seated in the skull.

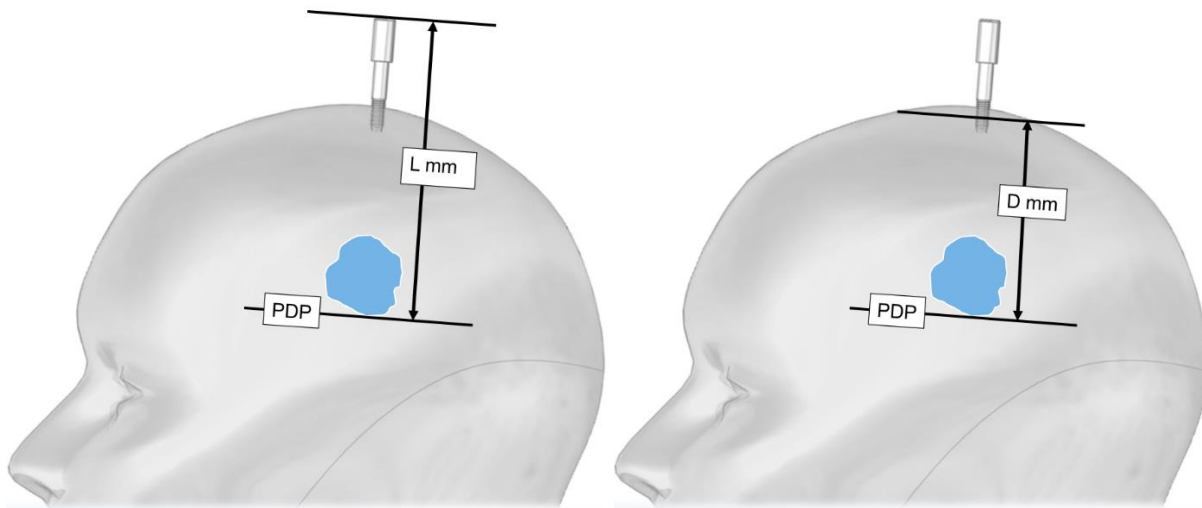

**Figure 8.2.9: Distance to Target Measured from the Skull Bone Anchor or Skull Surface**

Figure 8.2.9 (left): Measure the distance “L” by placing the navigation pointer at the surface of the skull bone anchor and use the navigation system to establish the distance from the top of the anchor to the deepest point of the target (PDP). Refer to the instructions for use of the respective targeting or navigation system being used for more detail as needed.



**CAUTION: PDP LOCATION** -This position defines the depth setting of the LDP and thus the deepest point of penetration of the probe tip during probe insertion. During MR guided probe insertion, the probe can begin treatment from any depth setting along trajectory. The PDP must be defined at a safe depth location since probe linear motion can extend to this point.

Figure 8.2.9.1 (right): Manual calculation can also be accomplished without the use of a stereotactic navigation system. In this case, measure the distance “D” from the outer table of the skull to the deepest point of the target (PDP) and add 36mm to account for the length of the skull bone anchor. Therefore, the distance “D” + 36mm is equal to “L.”

### 8.2.9.1. Length & Depth Stop Setting for 2.2 & 3.3 mm LDP - with a Probe Driver



When using the probe driver, the length of the probe driver must be accounted for when determining the correct laser probe length and depth stop setting. The table below shows how the probe length and depth stop settings correspond the desired PDP (distance “L” or “D”) when the probe driver is used. The ruler used to set the depth stop is supplied with the probe and must be set to a distance equal to “L” (all measurements/distances are within  $\pm 1\text{mm}$ ).

LDP Size	LDP Depth Stop Setting		Distance to PDP (“L”) with Probe Driver		Distance to PDP from Outer Table of Skull (“D”) with Probe Driver	
	Minimum	Maximum	Minimum	Maximum	Minimum	Maximum
000	78 mm	98 mm	38 mm	98 mm	2 mm	62 mm
00	99 mm	119 mm	59 mm	119 mm	23 mm	83 mm
1	120 mm	140 mm	80 mm	140 mm	44 mm	104 mm
2	141 mm	161 mm	101 mm	161 mm	65 mm	125 mm
3	162 mm	182 mm	122 mm	182 mm	86 mm	146 mm
4	183 mm	203 mm	143 mm	203 mm	107 mm	167 mm
5	204 mm	224 mm	164 mm	224 mm	128 mm	188 mm

### 8.2.9.2. Length & Depth Stop Setting 2.2 & 3.3 mm LDP without a Probe Driver

The tables below show how laser probe length and depth stop settings correspond the desired PDP (distance “L” or “D”) when no probe driver is used. The ruler used to set the depth stop is supplied with the probe (all measurements/distances are within  $\pm 1\text{mm}$ ).

LDP Size	LDP Depth Stop Setting		Distance to PDP (“L”) with no Probe Driver		Distance to PDP from Outer Table of Skull (“D”) with no Probe Driver	
	Minimum	Maximum	Minimum	Maximum	Minimum	Maximum
000	78 mm	98 mm	133 mm	153 mm	97 mm	117 mm
00	99 mm	119 mm	154 mm	174 mm	118 mm	138 mm
1	120 mm	140 mm	175 mm	195 mm	139 mm	159 mm
2	141 mm	161 mm	196 mm	216 mm	160 mm	180 mm
3	162 mm	182 mm	217 mm	237 mm	181 mm	201 mm
4	183 mm	203 mm	238 mm	258 mm	202 mm	222 mm
5	204 mm	224 mm	259 mm	279 mm	223 mm	243 mm

When using the ruler without a probe driver, the laser probe depth stop must be set to a distance equal to “L” minus 55 mm.

If using anchoring devices other than those available from Monteris Medical, please refer to the respective manufacturer’s Instructions for Use.

### 8.2.9.3. Length & Depth Stop Setting for 1.6 mm NB3 Probe



The NB3 laser probe is provided in a single length with a floating depth stop. Refer to sections 8.6.1.2 & 8.6.1.3 for instructions to set depth to measurement “L” described in section 8.2.9.

## 8.3. *PREP FOR TRANSFER TO MRI*

For NeuroBlate procedures performed in a Diagnostic MRI the sterile field created around the LDP delivery platform must be maintained throughout the entire procedure. Drape the patient head for transfer to the MRI according to hospital procedure. A sterile bag may be placed around the patient head and sterile field.

For NeuroBlate procedures performed in an intra-operative MRI, the sterile field created around the LDP delivery platform must be maintained throughout the entire procedure following hospital procedure.

For IMRIS surgical suites, ensure the table height is set to center the head at the MRI bore isocenter as well as ensure that the table is level.

## 8.4. INTERFACE PLATFORM (IP) ATTACHMENT/DETACHMENT



Refer to the Monteris Medical AtamA Stabilization System Instructions for Use.

Depending on the site-specific workflow, the Interface Platform (IP) may be attached before or after MRI trajectory confirmation. The order of these steps may be determined with the MRI or Surgical Support Team during on-site training, led by the Monteris Clinical Team.

**Note:** In certain workflows where Manual Mode is used (when not using the Robotic Probe Driver), the Interface Platform body may not necessarily be attached.



**CAUTION:** Every attempt should be made to keep fluids away from the IP and PCM by creating a plastic draping barrier. Fluid contact may interfere with the IP operation or cause failure of the device.

The method of attachment of the Interface Platform depends on the MRI type and system provided. All possible connection types are reviewed below. If multiple arm configurations are present, the method of IP to arm connect/disconnect is highlighted below. Always ensure Interface Platform and Arms are securely fastened before attaching both to the MRI table.



### Use of Siemens Aera and Skyra MRI

Prior to use of the AtamA Stabilization System and NeuroBlate Interface Platform, a fluid barrier must be placed over the coil connections and connectors on the MR couch. Plastic drapes should be placed over the coil connections (when not plugged in) and over the coil connectors when plugged in.

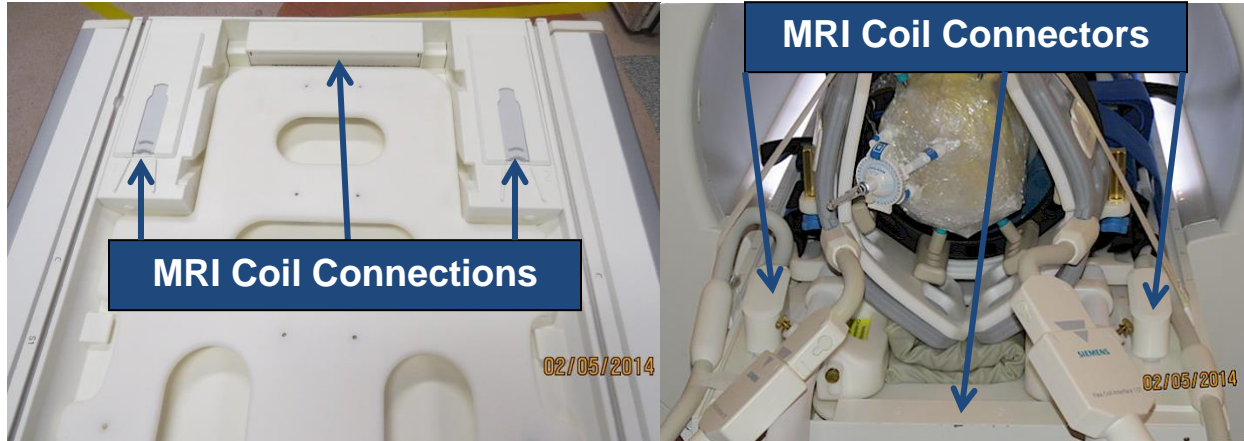

**Figure 8.4: MR Coil Connections for Siemens Aera and Skyra MRI**



**WARNING:** Fluids must not come in contact with the MR coil connections at the head end of the MRI table. A fluid barrier must be placed over the coil connections to prevent patient or operator injury and damage to the MRI system.

### Attachment Method 1– AtamA Attachment Interface

1. Ensure AtamA patient board is fully installed and secure on the MRI table.
2. Slide the arm ends (furthest away from the interface platform) into the IP Arm interface completely until the “stop rings” touch the IP arm interface. (**Note:** A thumb screw is provided on each side to lock the arms in place. Do not over tighten these screws as they may damage the arm.)

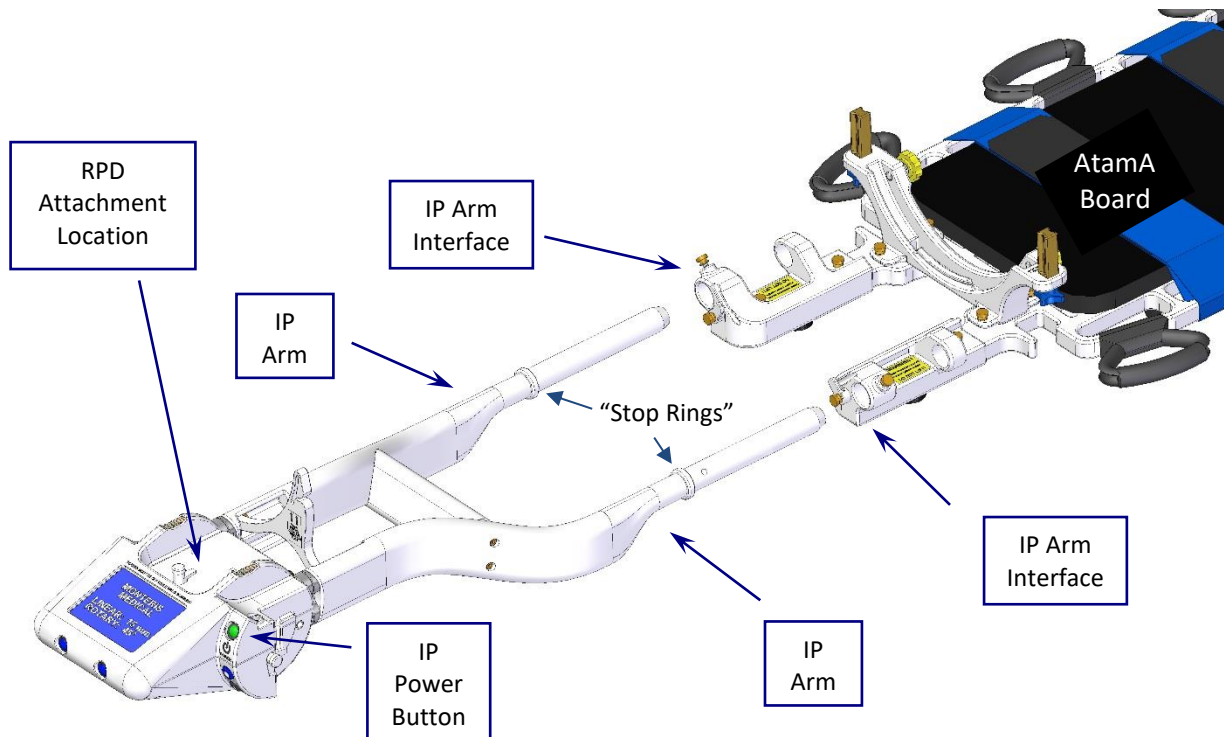

**Figure 8.41: Interface Platform (IP) to AtamA Connection**



**WARNING:** Do NOT lower the MRI table after the IP is attached to the AtamA Board. Doing so may lead to patient injury or equipment damage.

### Attachment Method 2 – IMRIS Table Receptacle

1. Remove the IMRIS OR table headrest if not needed for procedure. If needed for procedure, attachment method 3 should be used in conjunction with a different arm set.
2. Insert the IP arm's brass posts into the headrest receptacles (the receptacles may be square or circular depending on model). Ensure they are fully inserted and the white plastic portion of the IP arms rest against the table.
3. Tighten the IMRIS OR table's Mounting Knob to lock the IP arm brass posts to the table (Figure 8.42 e). For the square configuration, tighten the retaining thumbscrew into the side of the table after full insertion (Figure 8.42 f).

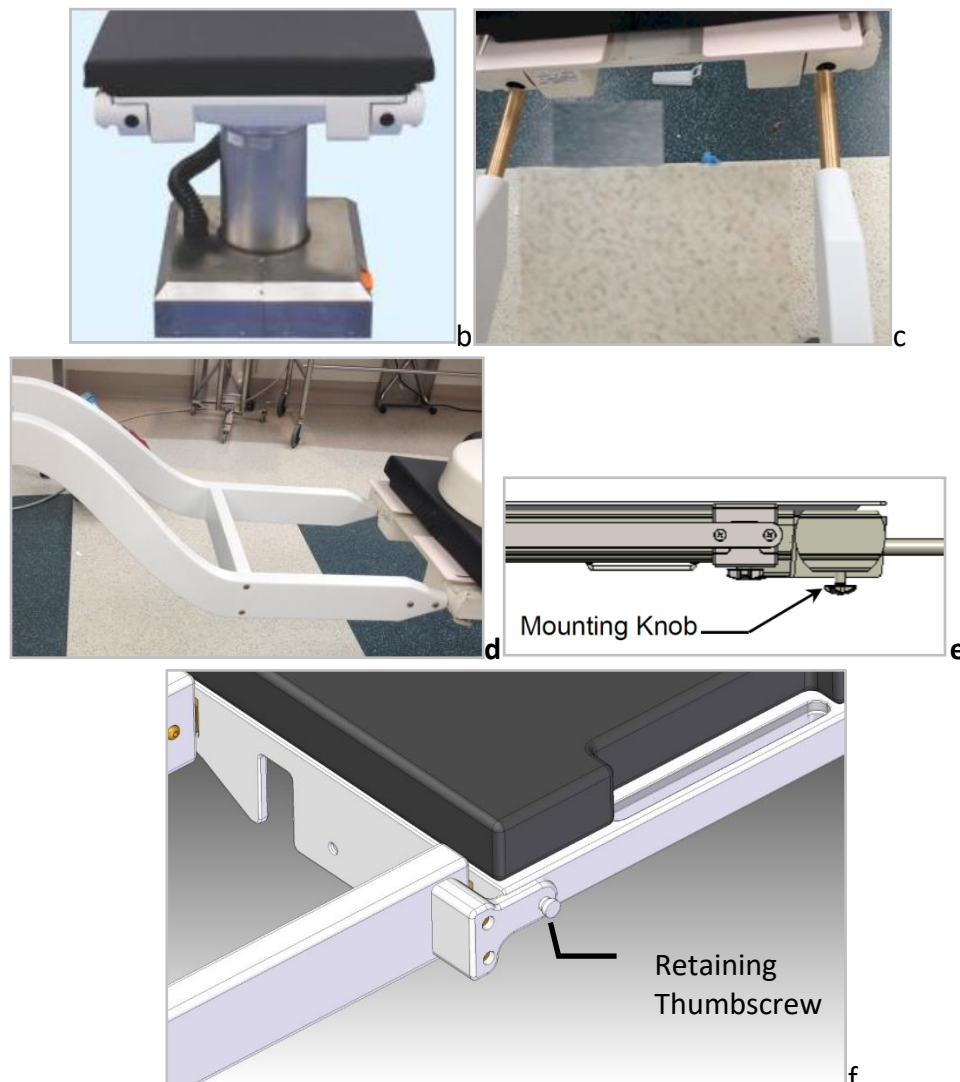

**Figure 8.42: Interface Platform to IMRIS Head Rest Mounting Holes**

### Attachment Method 3 – IMRIS Side Rail Attachment

1. Place both clamp pieces on each side rail by screwing clamp knobs in from bottom. Ensure clamps are flush with end of table. If IMRIS clamp is in the way, slide further down rail as to not interfere with the NeuroBlate attachment or procedure.
2. Insert arms through side holes and tighten clamp knob onto the arm shaft. Note: Do not over tighten the screw as this may damage the plastic.

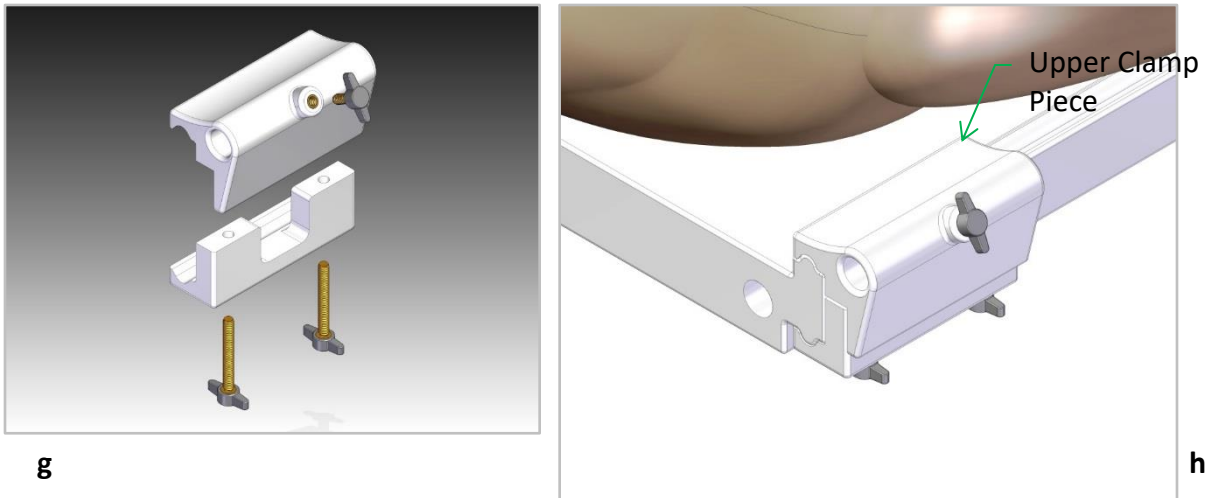

**Figure 8.43: Interface Platform to IMRIS Side Rail Arm Mounting**

### Attachment Method 4 – Siemens Table Slot Attachment

1. Place both Table Blocks on the MRI table as shown. **Note:** There are two different arm anchor types depending on table. The figures below highlight the differences.
2. Slide the Table Anchors up through the second MRI Table Slot on each side. Insert thumbscrews through the anchors and into the Table Blocks.
3. Slide the IP Arm Tabs into the Table Block Slots (red arrows).
4. Insert the Pivot Pins through the Table blocks and into the Interface Platform Arms (green arrows).

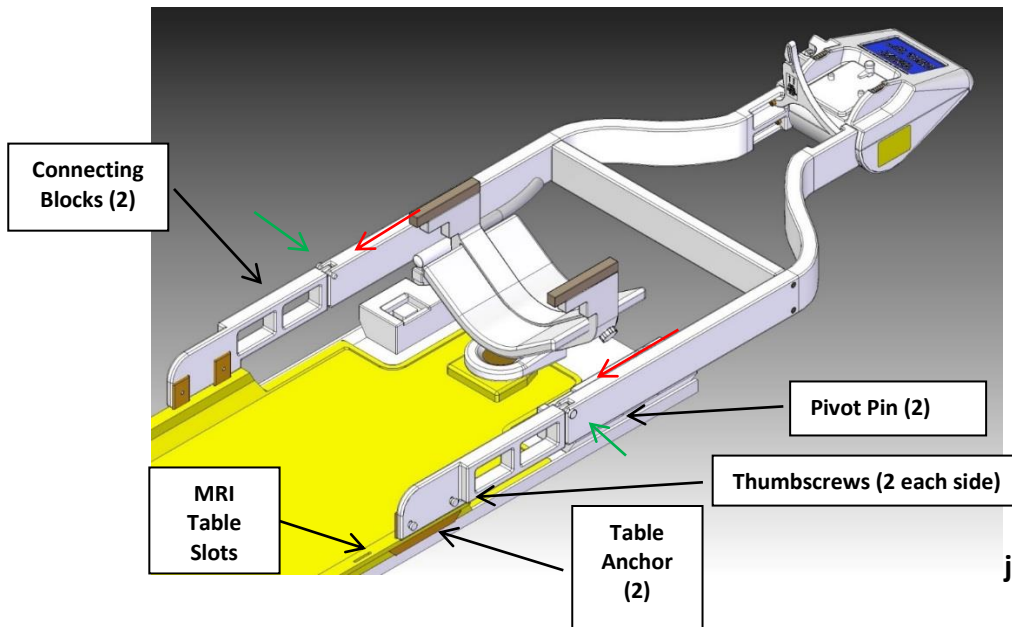
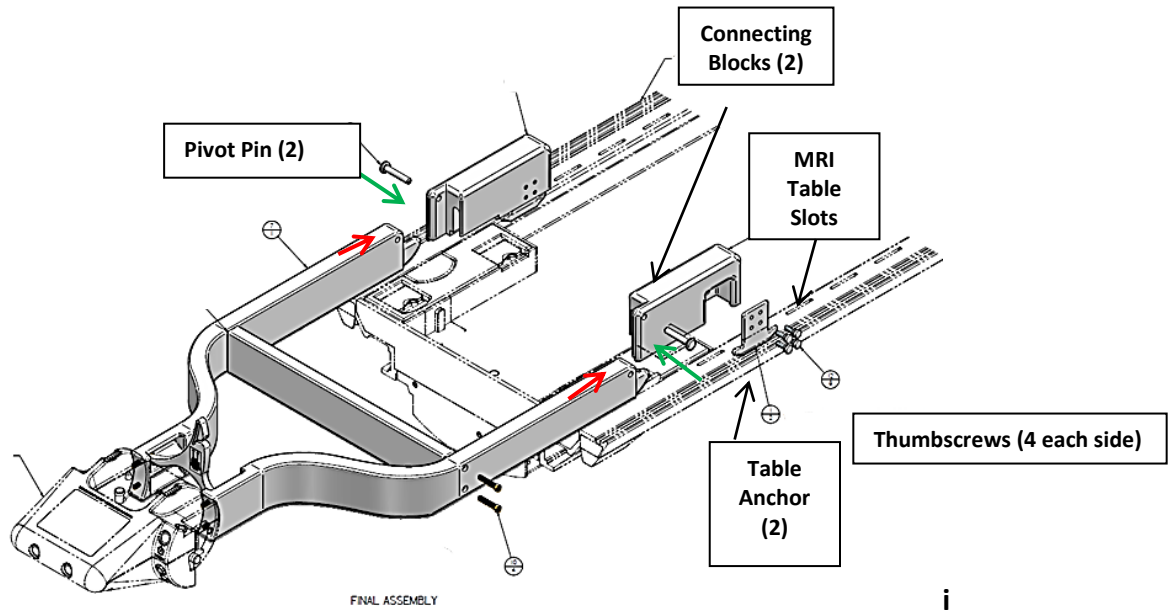

**Figure 8.44: Interface Platform to Siemens Table**

### Attachment Method 5 – Philips Ingenia MR table

1. The Philips “DStream” coil connection interface must be inserted into the head end of the MR and connected in order to use the Philips SENSE Flex coils (See Figure 8.45)
2. Ensure AtamA patient board is fully installed and secured on the MRI table in a position which does not interfere with the “DStream” coil connector interface (See Figure 8.46).
3. Plug the Philips flex coils into the “DStream” interface before installing the interface platform. The position of the interface platform arms may interfere with coil connection if the arms are installed first.
4. Slide the arm ends (furthest away from the interface platform) into the IP Arm interface completely until the “stop rings” touch the IP arm interface. Pay attention to the coil connectors and other components of the “DStream” interface as the arms are installed to prevent damage. (**Note:** A thumb screw is provided on each side to lock the arms in place. Do not over tighten these screws as they may damage the arm.)
5. If it is necessary to remove the Flex coils, it may require adjustment of the IP arm position within the arm interface temporarily to prevent interference with coil connector removal. Simply loosen thumb screw and partially slide out arms as needed.

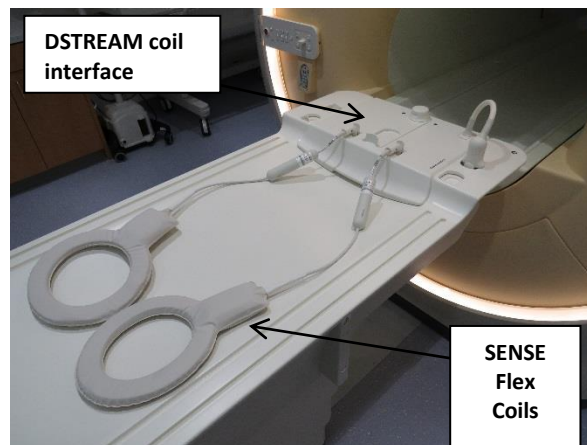

**Figure 8.45: Philips Ingenia MR Table with “DStream” coil interface**

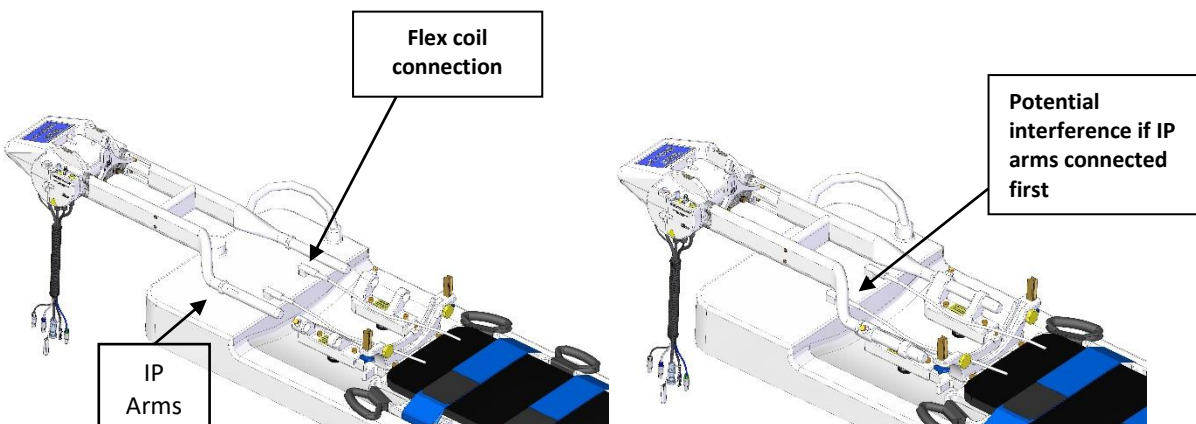

**Figure 8.46: IP Arm attachment to Philips Ingenia MR Table**

### Interface Platform to Arm Connection Connect/Disconnect

The interface platform can be attached and detached quickly from the arms by attaching and removing the brass thumbscrews shown in Figure 8.46.

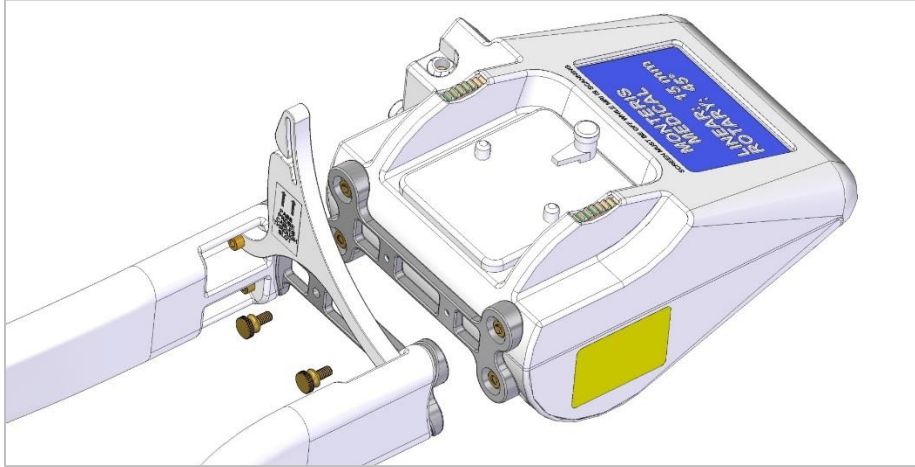

**CAUTION:** Ensure that excessive strain is not placed on the LDP or Probe Connectors.

The portable connector module (PCM) (Figure 8.47) can be placed in multiple positions along the Interface Platform (IP) arms via an adjustable bracket or on the IP housing itself. A strap is provided as redundant securement to the IP arms as well as for storage. The bracket is attached to the IP arm as shown in Figure 8.47 (right) and engaging the bracket locking thumbscrew finger tight.

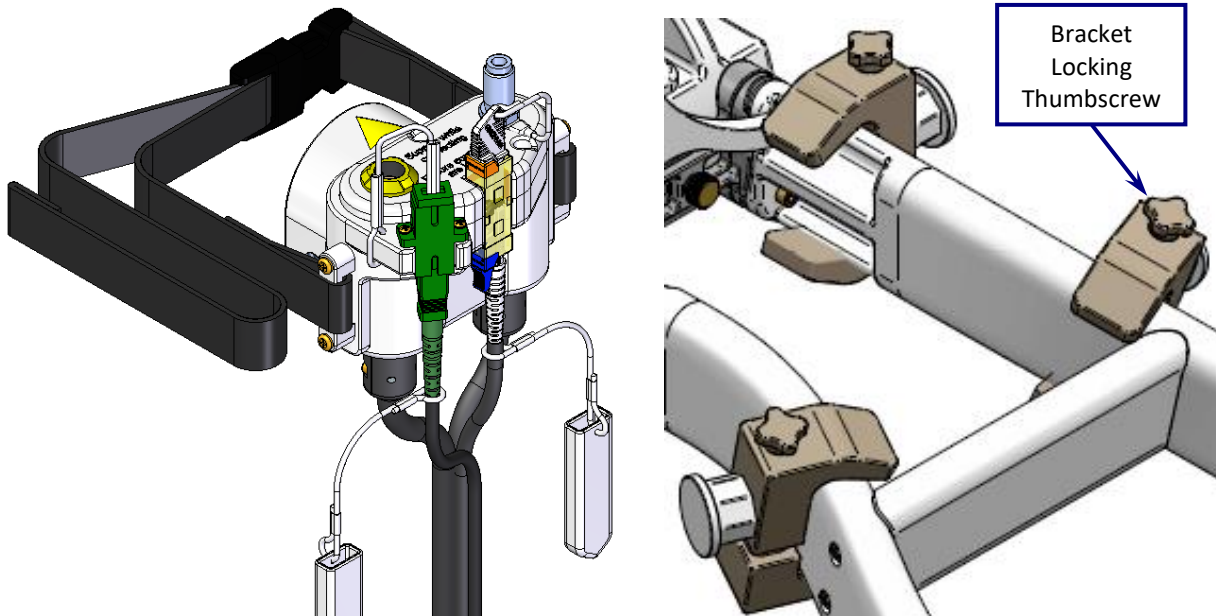

**Figure 8.47: Portable Connector Module with Strap (left);  
Mounting Bracket Assembled to IP Arms at Multiple Positions (right)**

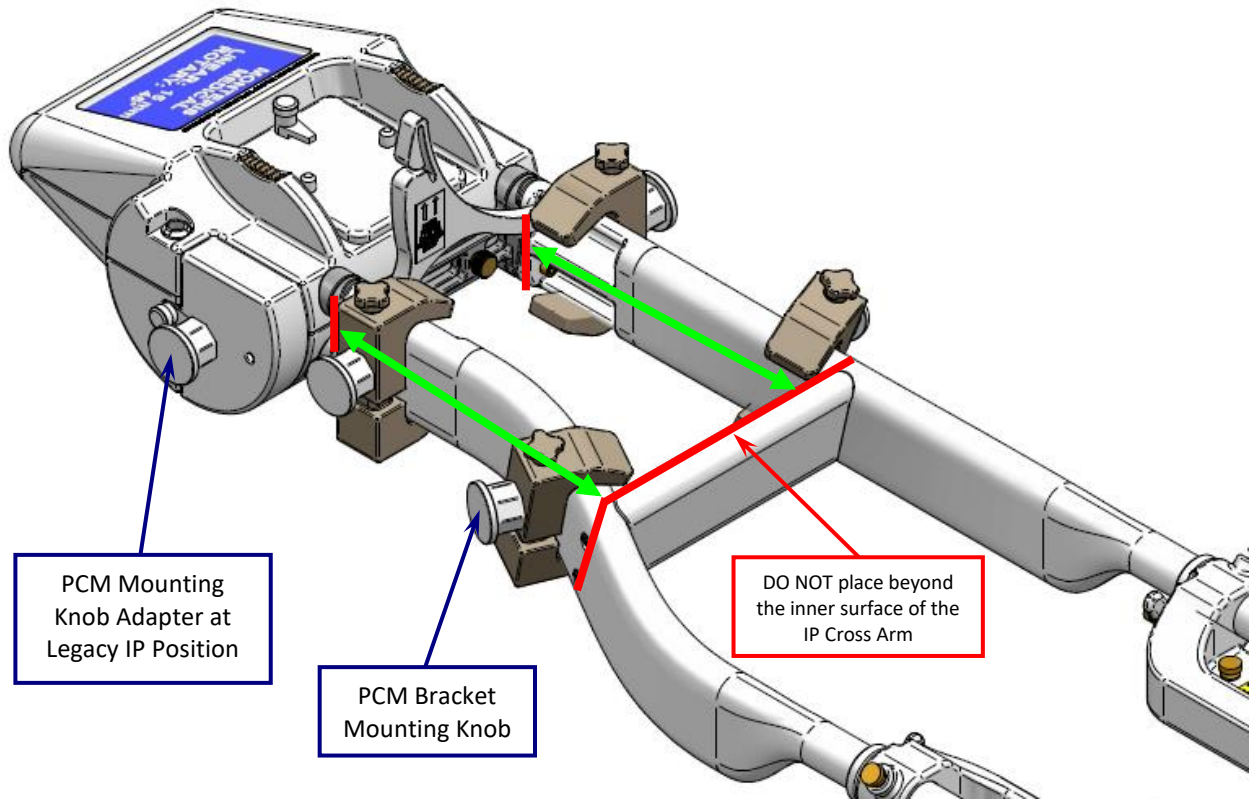

**Figure 8.48: PCM Mounting Position Limits (green arrows denote acceptable mounting position range; red lines denote mounting position boundaries)**

The PCM may be mounted via the adjustable bracket on the IP arms or on the IP housing itself via an adapter assembled at the legacy position by Monteris Service personnel. The adjustable brackets which attach the PCM to the IP arms may only be mounted within a certain range of positions on the arms as noted by the green arrows in Figure 8.48. As shown above, no part of the bracket may ever be placed outside of the red boundary lines. The PCM may be rotated on the mounting knob at preset rotations of 0, 45 or 90 degrees to the patient head.



**WARNING:** Do NOT place the PCM mounting bracket beyond the acceptable mounting positions noted in Figure 8.48. Equipment damage or malfunction due to radio frequency energy may occur if the PCM is placed too close to MRI isocenter.



**CAUTION:** Avoid product setups where cabling is taut. This can result in damage or inability to remotely move the probe.

- Using medium force, pull back on the PCM bracket mounting knob to ensure secure attachment

**Note:** For Manual Mode workflows: To avoid inadvertent strain or movement of the LDP, the IP arms should still be placed to hold the PCM.



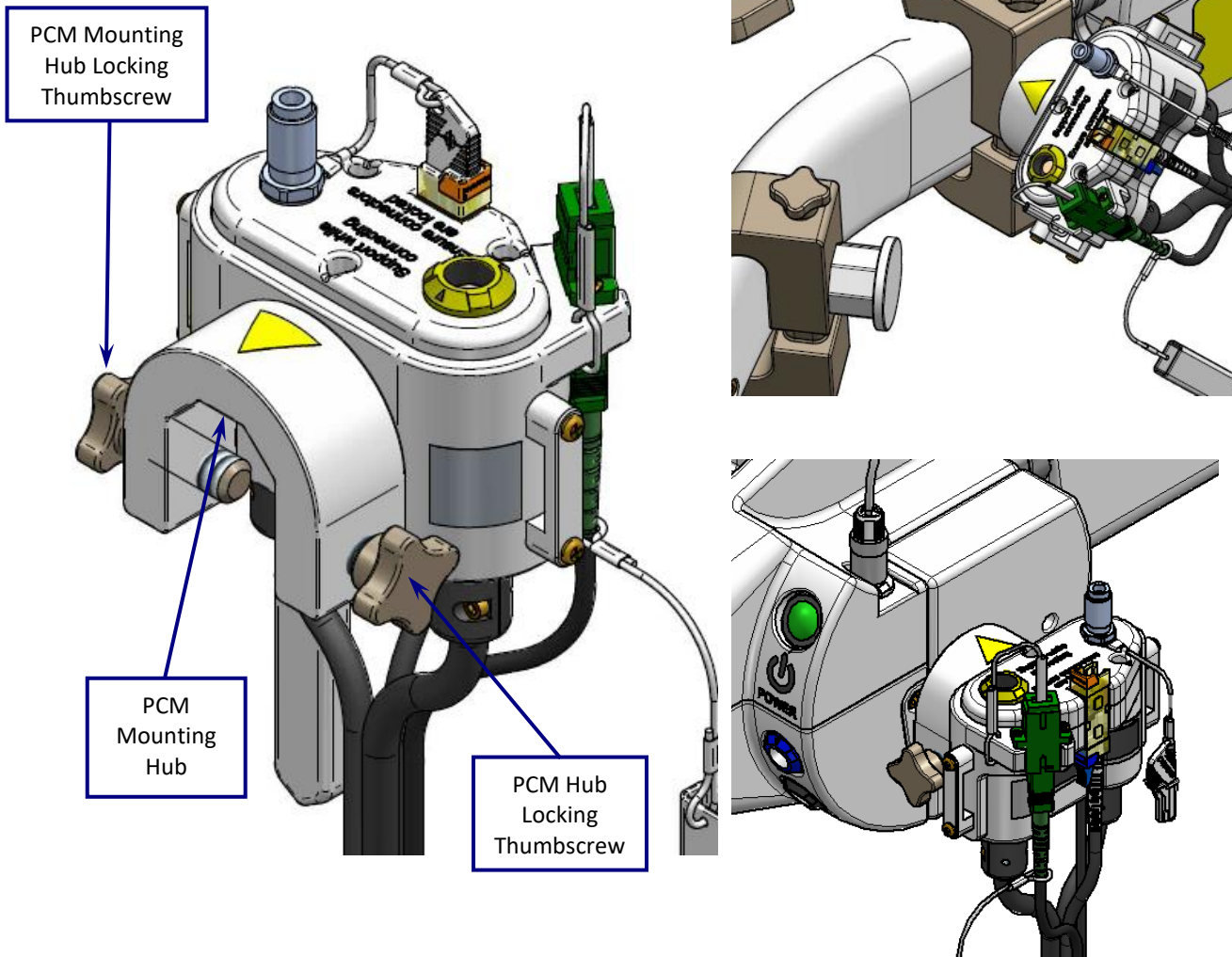

**Figure 8.49: PCM Mounting Hub (left); PCM mounted to IP Arms at 45° (top right); PCM to IP at 0° (bottom right)**

- Slide the U-shaped PCM’s mounting hub over the desired mounting hub (figure 8.49)
- Rotate the PCM to the desired, preset rotational positions (0°, 45° and 90°)
- Tighten the PCM mounting hub’s locking thumbscrews until contact is just felt between the thumbscrews and Mounting Bracket (image right shows how far the screws should protrude)
  - DO NOT overtighten thumbscrews

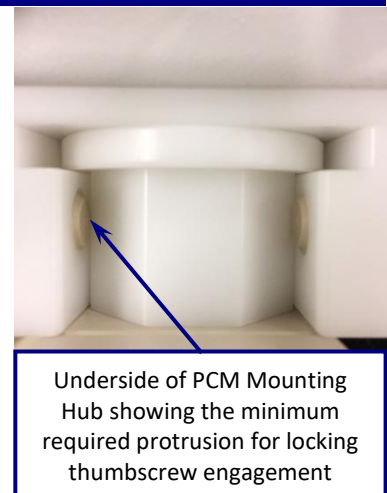



---

**CAUTION:** Ensure that excessive strain is not placed on the LDP or Probe Connectors.

---

- Wrap the redundant PCM strap around the IP arms if using the bracket and secure
- The user must ensure the PCM and bracket is fully secured to the desired attachment position. Use medium force to lift up and pull back on the PCM to confirm attachment
- The user must ensure that the PCM cable bundle extending to the penetration panel has sufficient slack in the line to allow the MRI table to move to iso-center without snagging the MRI scanner or other equipment
- Attach the IP Power and Motor Plugs which extend from the (see image right)

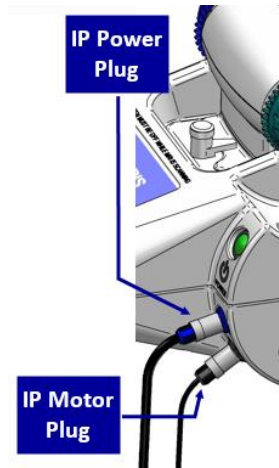

---

**CAUTION:** Ensure the PCM and cables (e.g., Position Feedback Plug) are not resting on or in close proximity to the patient during imaging.

---



---

**WARNING:** If employing manual manipulations of the LDP where the Interface Platform is not used, ensure the PCM is properly secured to the IP arms to prevent inadvertent strain or movement of the LDP which could lead to patient injury.

---

## 8.5. PROBE DRIVER ATTACHMENT

Once the Interface Platform is attached to the AtamA patient board or the IMRIS surgical table the sterile Probe Driver can be connected.

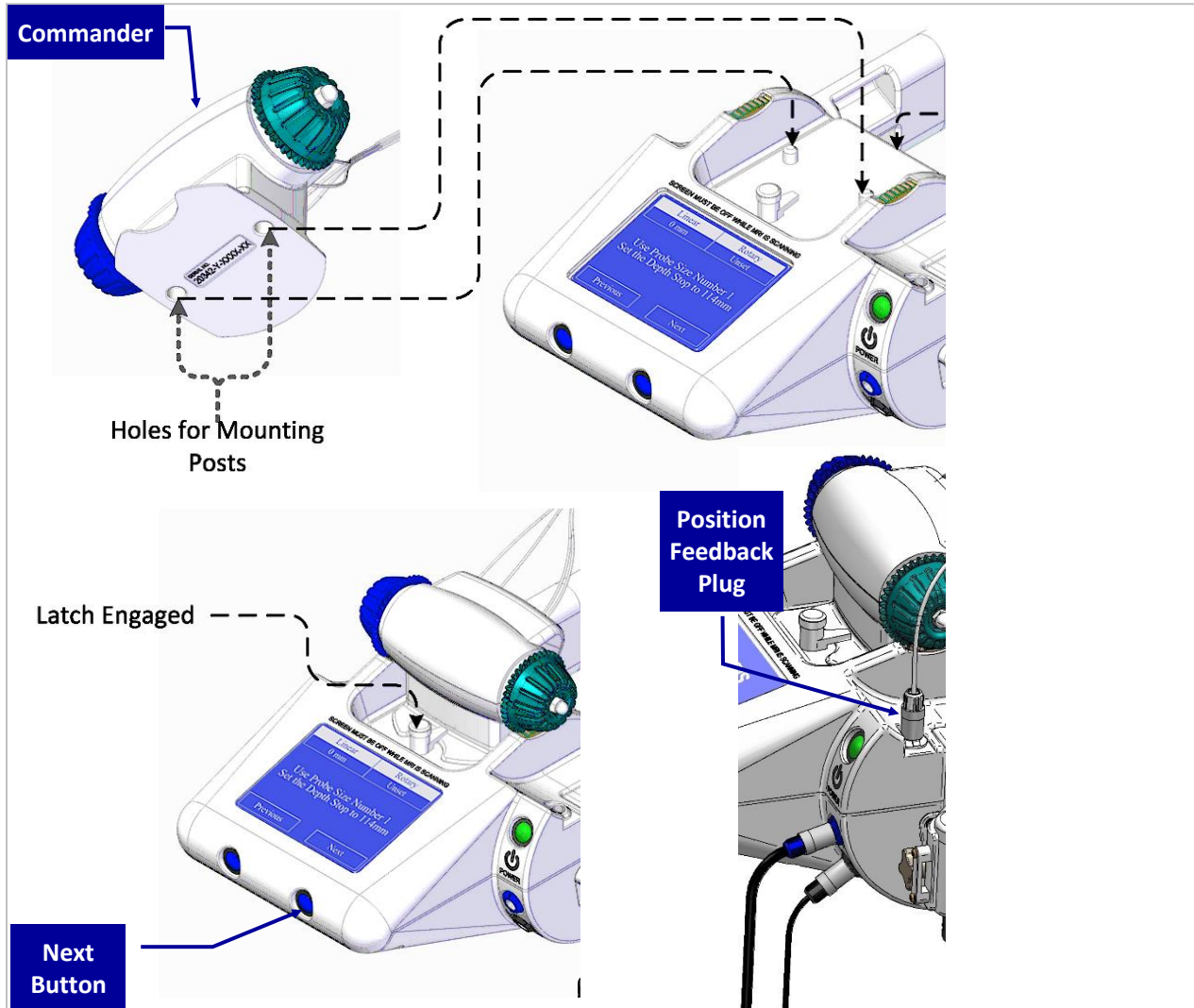

**Figure 8.51: Probe Driver Connection to Interface Platform (IP)**

- Ensure the IP is properly attached to the AtamA patient board
- Ensure the IP Power and Motor Plugs are inserted into proper receptacles on the IP
- Using aseptic technique, peel the Tyvek® covering back from sterile package corner. Remove cover, then remove plastic lid from sterile tray
- Pass the RPD Commander out of the sterile field
- Attach the Commander to the IP and engage the Latch to lock the Commander in place by twisting the Latch to the centered position (see Figure 8.51)

- Connect the Position Feedback Plug (cable) as shown in Figure 8.51

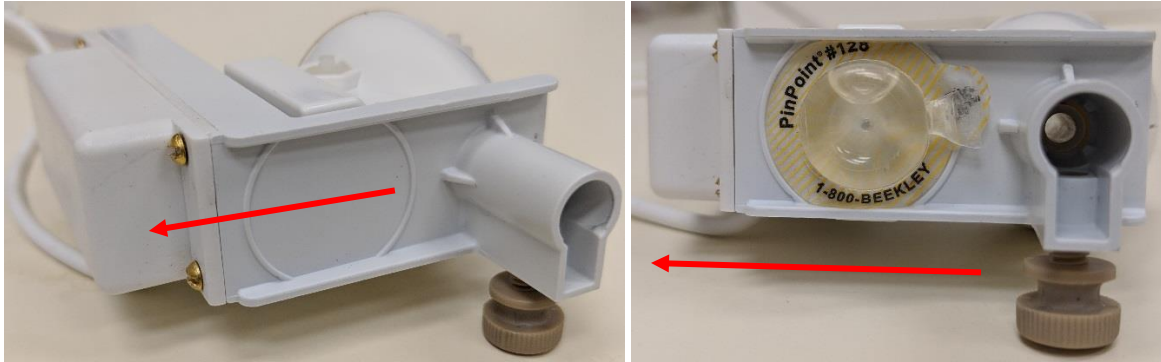
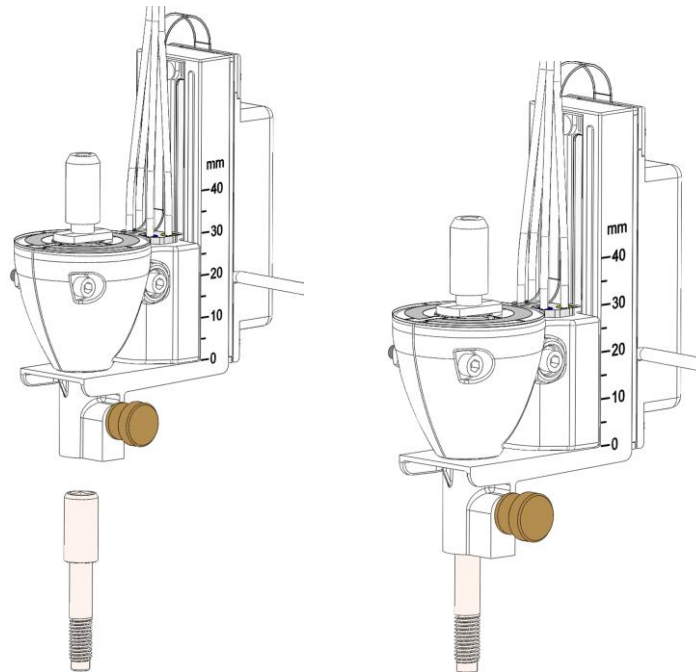

**Figure 8.52: Location for Fiducial Marker on RPD**

When using a SideFire LDP, ensure the direction of laser energy delivery is correct when aligning and connecting the RPD follower. A sterile, MRI-visible fiducial marker may be placed on the underside of the Probe Driver Follower to help determine laser directionality as shown in Figure 8.52.

If a fiducial marker is not used, rotate the Follower while on the skull bone anchor so that the back side is pointing in the direction of the patient’s nose as shown as red arrows in Figure 8.52.

### 8.5.1. Workflow using Skull Bone Anchor and Robotic Probe Driver (RPD)



**Figure 8.5.21: Attaching the RPD to the Skull Bone Anchor**



**CAUTION:** Ensure the PCM and cables (e.g., Position Feedback Plug) are not resting on or in close proximity to the patient during imaging.

- Slide the RPD Follower onto the bone anchor and tighten the thumbscrew securing RPD to bone anchor as shown in Figure 8.5.21

### 8.5.2. Automatic Mode Linear / Rotary Diagnostic Tests

This step is optional and can be completed prior to the procedure using a non-sterile RPD and LDP. It can only be performed when system is in Automatic (Robotic) Mode.

- Attach the Rotary Test Adapter (image right) if available or the LDP onto the RPD Follower to allow the Rotary Motion Test to be performed without the LDP inserted into the patient. The adapter (or LDP) inserted into the Follower is not required to perform a Linear Motion Test.



- Press the green *Power* button on the Interface Platform (IP) to power

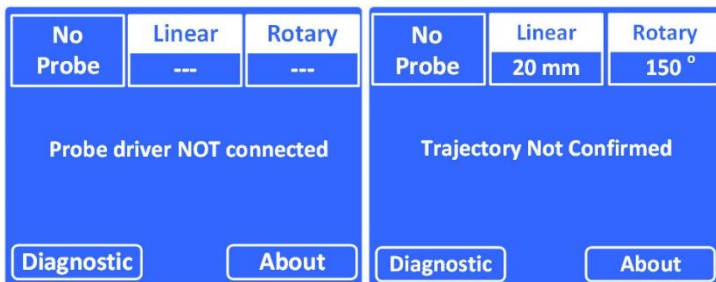

At IP startup, the display will read *Probe Driver NOT connected* if the Position Feedback plug has not yet been connected. Once plugged in, the display will read *Trajectory Not confirmed* and Linear and Rotary positions will be displayed assuming the Rotary Test Tool or LDP is connected. The blue Select and OK buttons will trigger the action above the button as shown on the IP display.

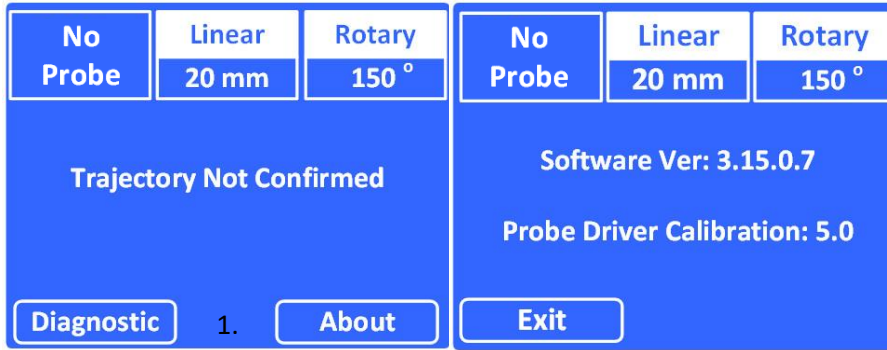

Pressing the blue OK button under *About* (image 1.) will change the display to the About screen (image far right) showing Software Version and Probe Driver Calibration. Pressing the Select button under *Exit* will change the display back to the startup screen.

1. Press the blue Select button under Diagnostic to initiate the Probe Motion Test:

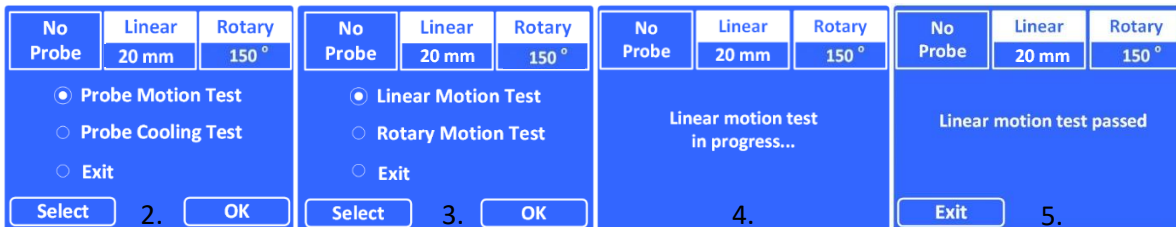

2. Press the blue OK button to start the Probe Motion Test
3. Press the OK button to start the Linear Motion Test
4. Wait for the test to complete
5. Press the Select button to *Exit* back to the Probe Motion Test screen

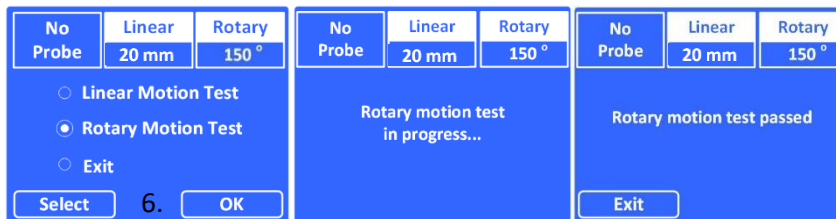

6. Use the Select button to highlight the Rotary Motion Test radio button and the OK button to initiate. When complete use the select button to Exit back to Probe Motion Test screen
  - Visually confirm that the Follower / Rotary Test Adapter is properly translating and rotating to correspond with the proper RPD knob motions
  - Replace the RPD if it fails to actuate the follower properly
  - Carefully remove the Rotary Test Adapter by depressing the green release button and pulling back from the Follower

## 8.6. LASER DELIVERY PROBE (LDP)

The 3.3 mm and 2.2 mm NeuroBlate Laser Delivery Probes (LDP's) are provided in multiple lengths and configurations for lesions of varying depths. Refer to section 8.2.9. Laser Delivery Probe (LDP) Length and Depth Stop Setting for more detail.

- Remove the LDP tray from the sterile pouch and place in the sterile field
- Peel the Tyvek® covering starting from corner to remove it from the LDP tray



**WARNING:** Use aseptic technique when handling the contents of the sterile package.

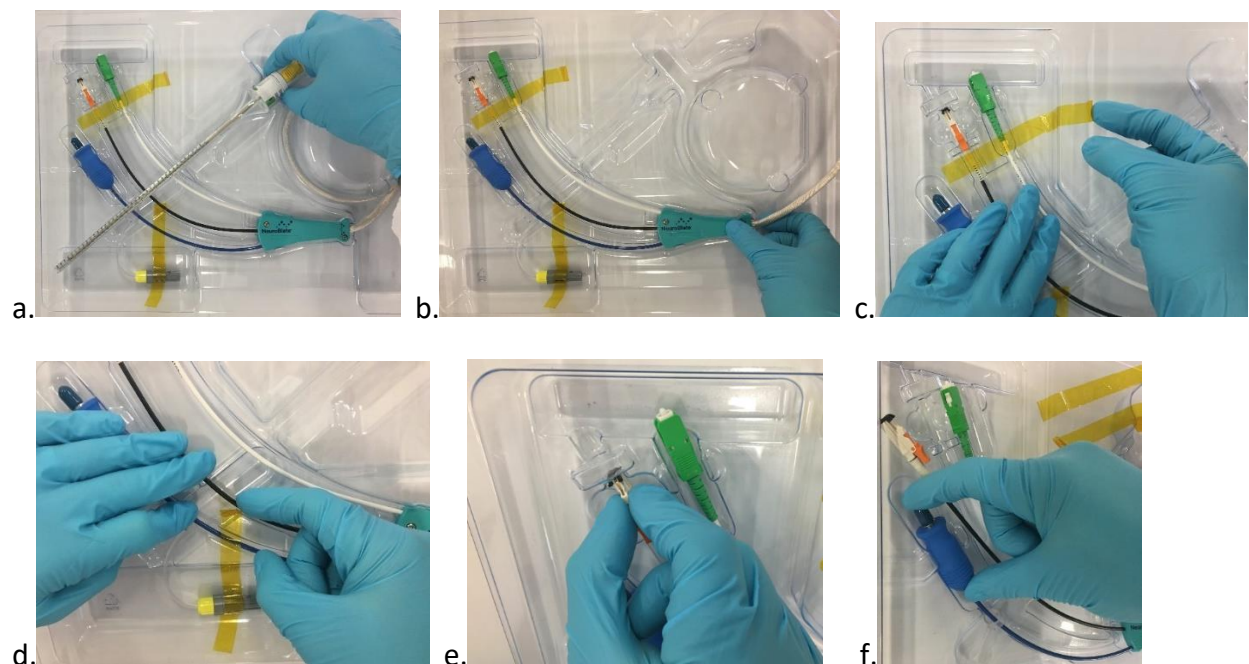

**Figure 8.6: Remove the LDP from the tray.**

- Remove the LDP main section by gently pulling up on the probe interface (Figure 8.6 a)
- Lift the clamp shell from the tray by gently pulling up on its plastic body (Figure 8.6 b)
- Remove tape holding the probe detection and temperature sensor plugs (Figure 8.6 c & d).
- Carefully pull the laser fiber connector up and out from the tray to ensure the fiber line is not bent near its connector. (Figure 8.6 e)
- Gently lift up on the cooling plug to remove (Figure 8.6 f)



**CAUTION:** Never pull on the thinner tubular or cable sections of the laser, cooling, temperature sensor, and probe detection lines, as this may damage the components.

**CAUTION:** The Laser Delivery Probe is fragile. Handle with care.

The 1.6 mm NeuroBlate Laser Delivery Probe (LDP) is provided in a single length.

- Remove the LDP packaging card from the sterile pouch and place in the sterile field

**WARNING:** Use aseptic technique when handling the contents of the sterile package.

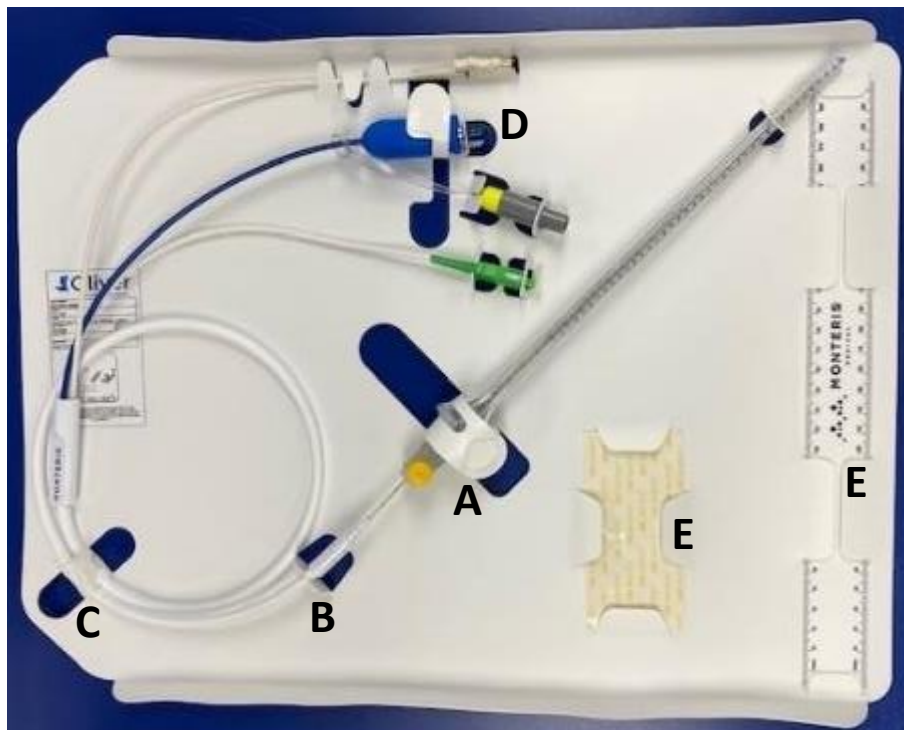

**Figure 8.6 A-D: Removing the 1.6 mm LDP from the Sterile Tray**

- Lift up to open the 3 card straps at the A, C and D positions (Figure 8.6)
- A. Lift the LDP depth stop and protective ruler by gently sliding the ruler from its holder
- B. Lift the probe umbilical from its holder by gently pulling up
- C. Continue lifting the coiled section of the umbilical
- D. Lift the laser fiber connector, cooling plug, probe detection and temperature sensor out of their holders
- E. Do not discard the Steri-Strips or plastic ruler and keep sterile until the end of the procedure

Note: Use caution when removing the plastic ruler to ensure it does not become bent  
 - to remove, disengage the tab at one end and carefully slide out



## 8.6.1. Setting the Laser Delivery Probe (LDP) Depth Stops

### 8.6.1.1. Depth Stop Setting for 3.3 mm and 2.2 mm LDPs - Robotic Probe Driver

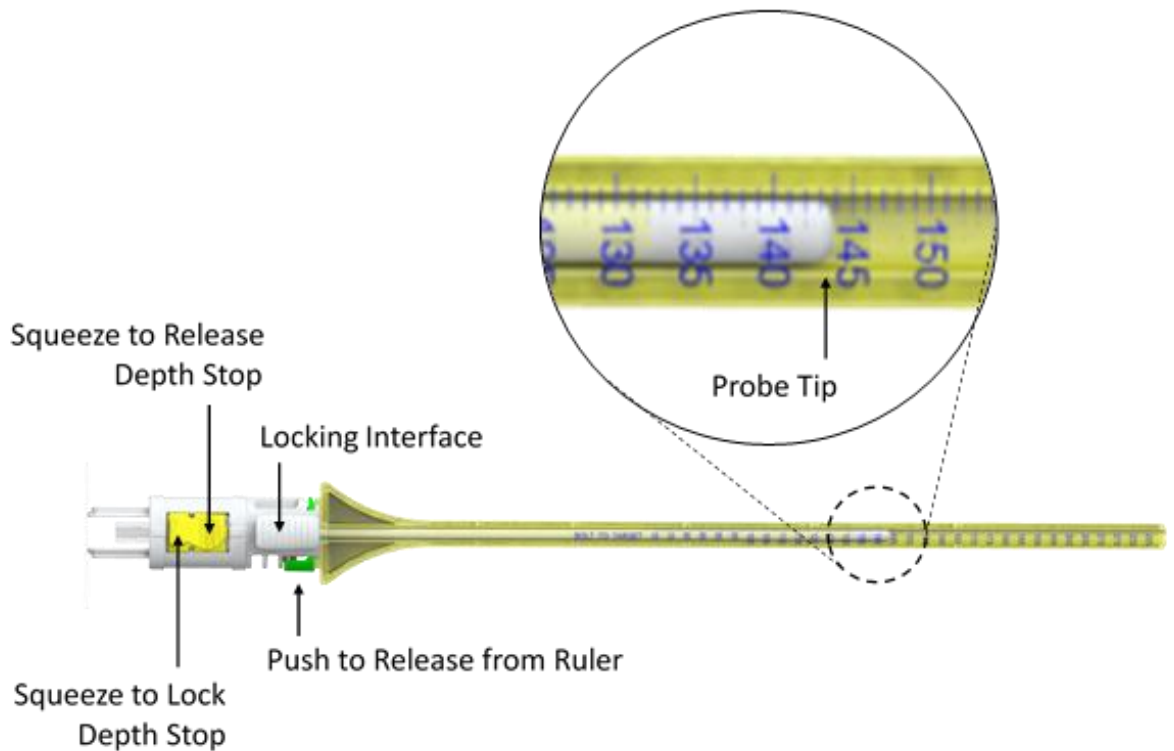

**Figure 8.6.1: Adjustment and Setting of Depth Stop**

- Ensure the LDP is fully inserted into the ruler provided as shown in Figure 8.6.1. When inserting the LDP into the ruler an audible click can be heard when fully inserted
- Squeeze the tapered (distal) end of both yellow buttons to unlock the depth stop
- Carefully slide the Locking Interface so that the tip of the LDP tip aligns with the desired distance measurement. Refer to Section 8.2.9 for details regarding the correlation between the depth stop setting and the point of deepest penetration (PDP)
- Squeeze the wide (proximal) end of both buttons to lock the depth stop. An audible click can be heard when locked
- Confirm the depth stop is locked by gently pushing and pulling on Locking Interface
- Ensure the depth stop is set to the desired length and locked prior to inserting the LDP into the brain



**WARNING:** An improperly set depth stop may allow the LDP tip to be delivered beyond the intended target which may lead to patient injury.

- Carefully remove the ruler from the LDP by pressing the green release button.



### 8.6.1.2. Floating Depth Stop for 1.6 NB3 Probe - Using the Robotic Probe Driver (RPD)

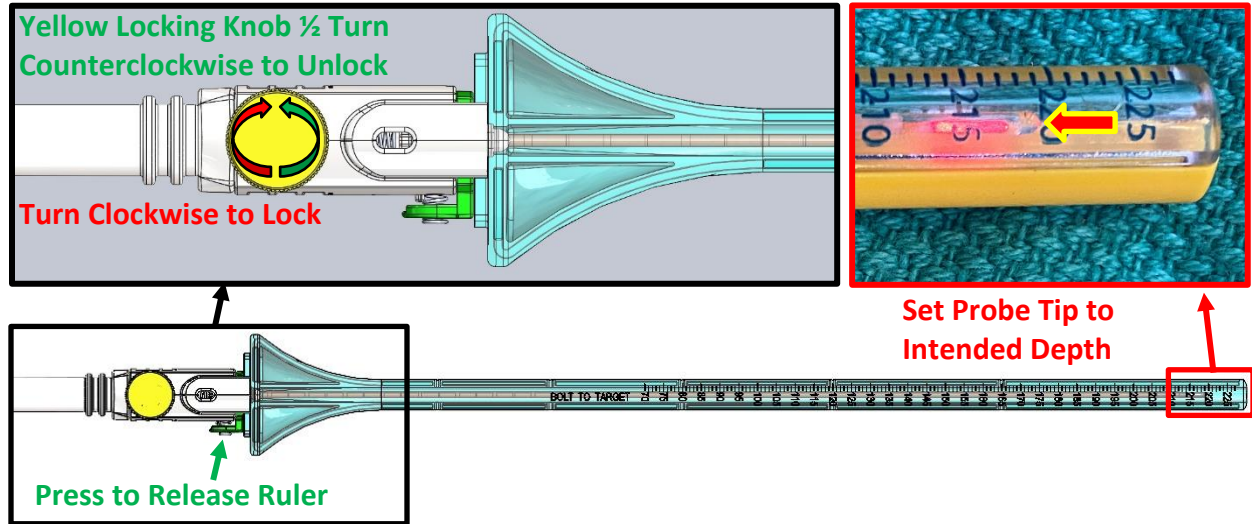

**Figure 8.6.12: Setting the Floating Depth Stop - 1.6 NB3 Probe**

- Ensure the probe laser fiber is plugged in and the probe's red pilot light is on for best visibility when setting the Floating Depth Stop
- Ensure the Floating Depth Stop is fully seated on the protective ruler. When inserting the LDP into the ruler an audible click can be heard when fully inserted
- Rotate yellow locking knob turn counterclockwise to unlock the depth stop (Figure 8.6.12)
- Carefully slide the LDP shaft out of ruler so that the tip of the LDP aligns with the intended distance measurement "L" - refer to Section 8.2.9 for details regarding the correlation between the depth stop setting and the point of deepest penetration (PDP)
- Rotate the yellow lock knob clockwise to lock the depth stop (the lock knob cannot be overtightened) (Figure 8.6.12)
- Confirm the depth stop is locked by gently pulling on the Floating Depth Stop while holding the LDP shaft at the strain relief
- Ensure the depth stop is set to the desired length and locked prior to inserting the LDP into the brain



**WARNING:** Ensure the Floating Depth Stop is fully locked to prevent patient injury.

- Carefully remove the ruler from the LDP by pressing the green release button.

### 8.6.1.3. Floating Depth Stop Setting for 1.6 LDP - Inserting Directly Through Mini-Bolt



**WARNING:** Use of the protective ruler (Figure 8.6.12) to set the floating depth stop when advancing the 1.6 mm probe into the brain using only a skull bone anchor (no RPD) may allow the LDP tip to be delivered beyond the intended target. This may lead to patient injury.

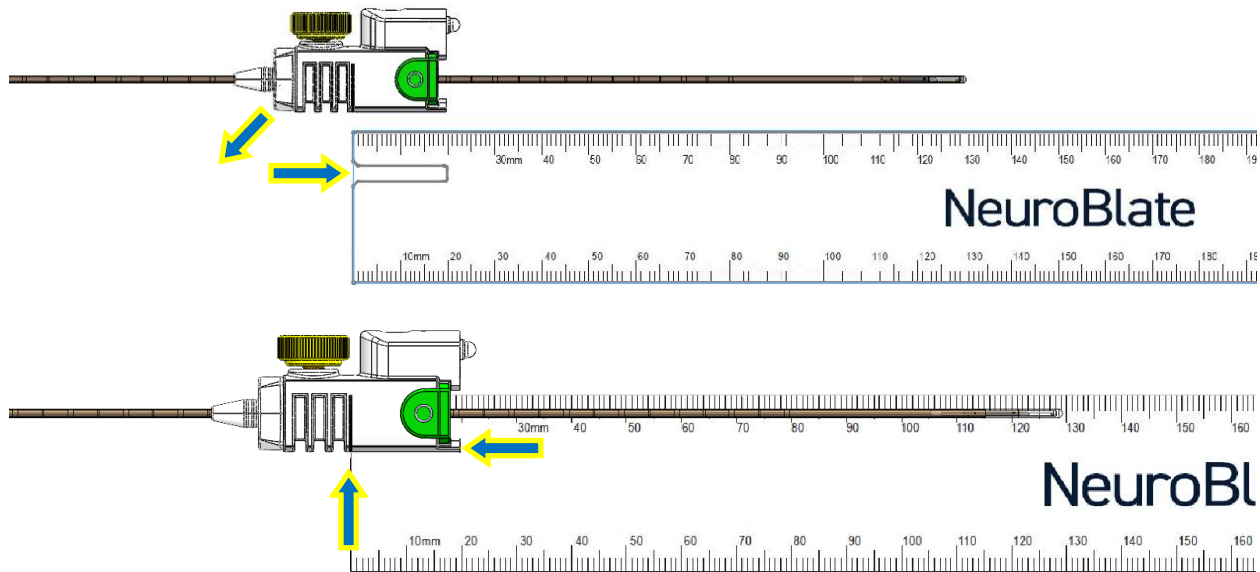

**Figure 8.6.13: Setting the Floating Depth Stop (1.6 mm LDP) with NO Robotic Probe Driver**

- Remove the 1.6 mm probe and Floating Depth Stop from the protective ruler
- Retrieve the sterile flexible plastic ruler from the NB3 packing card included with the probe
- Place the notched end of the ruler into the opening where the probe shaft exits the Floating Depth Stop, align the black line on the depth stop to the zero position at the end of the plastic ruler and lay the probe onto the surface of the ruler (Figure 8.6.13 arrows)
- Turn the yellow lock knob counterclockwise to unlock the depth stop
- Carefully slide the LDP shaft out of the depth stop until the tip of the LDP aligns with the desired distance measurement on the plastic ruler.
- Turn the yellow lock knob clockwise to lock the depth stop
- Confirm the depth stop is locked by gently pulling on the Floating Depth Stop while holding the LDP shaft at the strain relief
- Ensure the depth stop is set to the desired length and locked prior to inserting the LDP into the brain through the Mini-Bolt
- There are marked graduations on the probe shaft every 5 mm to guide the user when manually retracting the 1.6 mm LDP during the ablation procedure



**WARNING:** An improperly set depth stop may allow the LDP tip to be delivered beyond the intended target which may lead to patient injury.

### 8.6.2. Laser Delivery Probe Connections

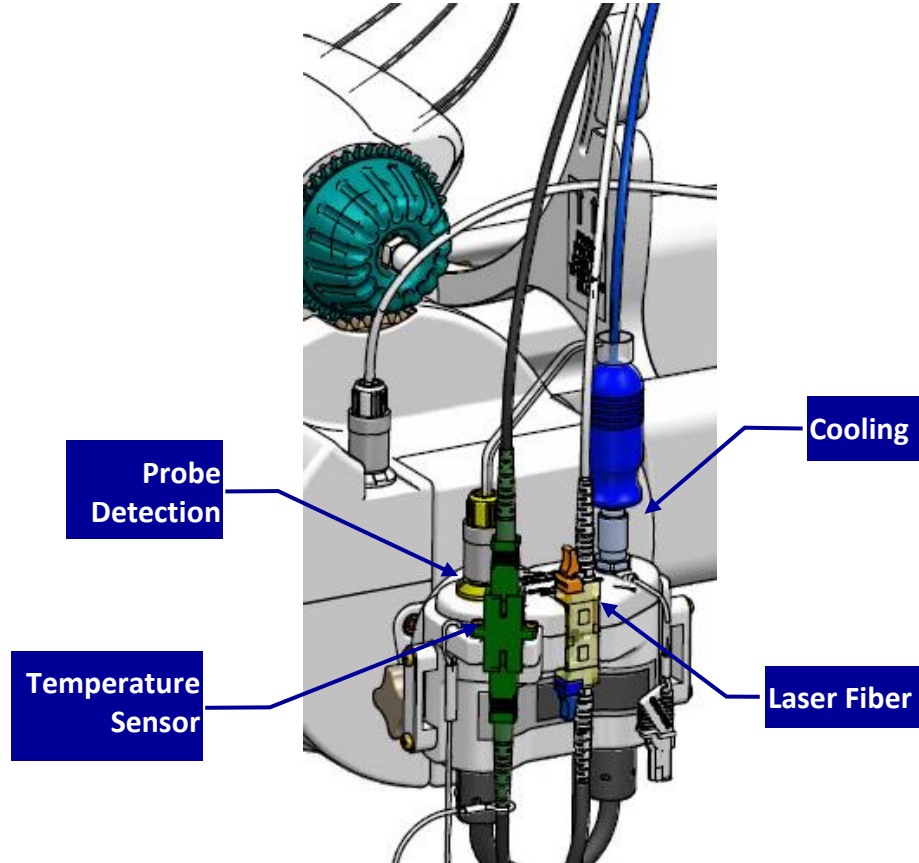
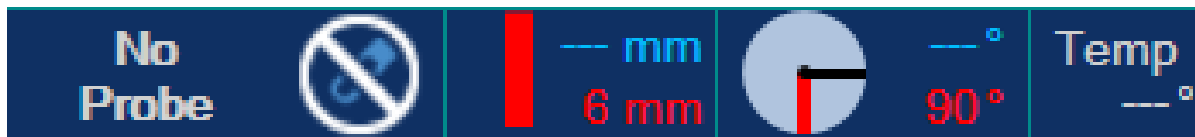

**Figure 8.6.2: LDP Connections on PCM**

The sterile person transfers the LDP connector plugs out of sterile field to a non-sterile person who inserts plugs into their receptacles on the PCM (see 8.6.2).

- Insert the cooling plug into its silver mating receptacle until the sleeve on the receptacle moves - it will click and lock when fully inserted
- Insert the probe detection plug into its yellow-colored connector until it clicks

**Probe Status Bar Display Change with Connection of LDP Temperature Tensor Plug:**



Once the LDP has been plugged into the interface platform, the Probe Status Bar as displayed in the software (above) will change to indicate the type of probe detected (below).

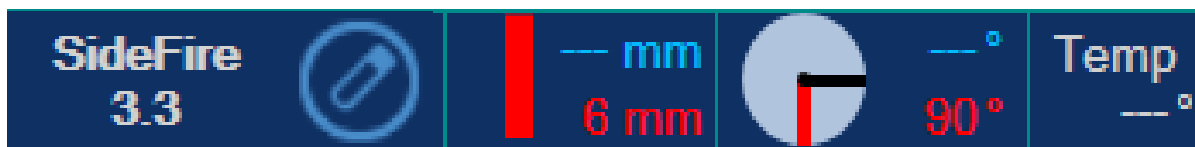

- The user must verify that the correct laser probe type has been detected

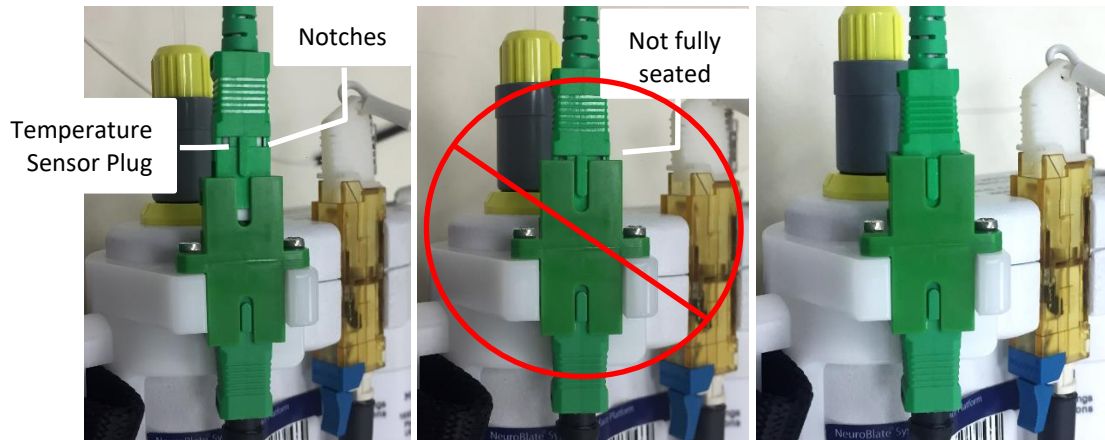

**Figure 8.6.21: Temperature Sensor - Partial Connection (middle); Full Connection (right)**

- Remove the dust cover and insert the temperature sensor plug into the green adapter connection by orienting the key on the plug with the groove on the adapter
- Visually verify that the notches on the temperature sensor plug are no longer visible to ensure it is fully connected (Figure 8.6.21)

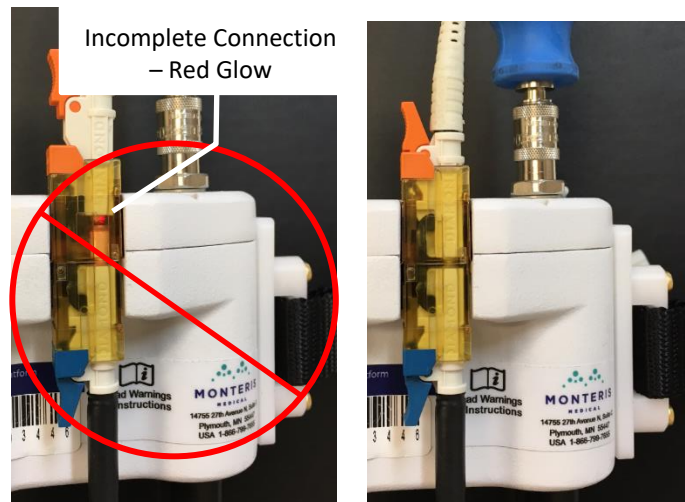

**Figure 8.6.22: Laser Fiber Plug Not Fully Seated - red glow in mating connector and gap between components (left); Laser Fiber Plug Fully Seated - no red glow in mating connector and no gap between components (right)**

- Remove the dust cover and insert the laser plug into the mating receptacle - two clicks should be heard: one at partial (half) insertion and one at full insertion
- With medium force, pull back on the laser fiber plug to ensure it is securely seated and cannot be disconnected

**Note:** There should be zero visible red glow at the laser fiber plug connector when fully connected. If a red glow is visible, check to ensure laser fiber plug is fully seated (Figure 8.6.22).

**Note:** The laser is disabled by the Fusion-S Software until the appropriate workflow step has been reached. The laser shall remain locked throughout the workflow until treatment monitoring begins. However, the visible pilot laser beam is always enabled. The visible pilot laser (red color) light is a class 2 laser product according to IEC 60825-1 with maximum power of 1 mW. The laser will NOT emit higher energy when the foot pedal is pressed during Self-Test. After system start-up, the red glow from the pilot laser will be visible in laser mating connector when the laser probe is not connected. After connecting the laser fiber plug, a visible red glow indicates an incomplete connection of the laser plug in the PCM.



**WARNING:** The LDP fiber connector must be completely engaged into the corresponding Interface Platform receptacle. Failure to do so may cause receptacle heating and reduce the energy delivered. This may result in equipment damage or injury to patient.



**WARNING:** To prevent user or patient injury, the cooling connector plug must never be disconnected when the line is pressurized during active LDP cooling.



**WARNING:** To prevent system damage, the dust covers must be inserted into the laser and temperature sensor connectors on the PCM when there is no laser probe connected.

- If the workflow requires the probe to be disconnected while the MRI (specific to IMRIS) is being moved into position, retain the three connector lines in the connector line bracket as shown (image right) - this will ensure that the lines remain fixed to the IP while disconnected

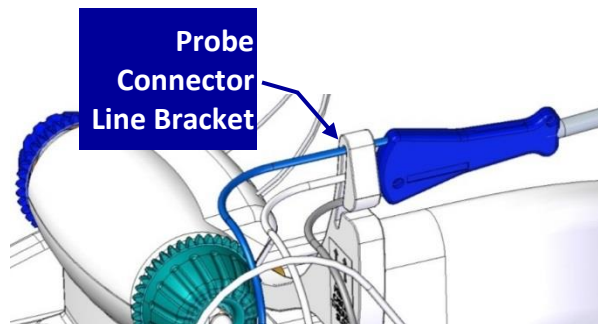

**WARNING:** The three LDP Connector lines must be retained in the LDP Connector Line Bracket to ensure force during disconnection of LDP is not transferred to the LDP after insertion into the Brain. Force applied to the LDP after insertion may lead to patient injury.



**WARNING:** The three LDP Connector lines must never be bent, kinked or crushed. This also applies to the laser fiber and all other lines within the Connector Module cable bundle. Damaged lines may result in LDP operation failure or may reduce laser energy delivered to the target tissue. Damaged portions of laser fiber lines may interrupt heating and may result in equipment damage or injury to the user or patient.

### 8.6.3. Cooling Test and Laser Aiming Beam (Pilot Light) Check

- Perform Cooling test while sterile person maintains the probe in hands
- Press the Power button on the IP if the display has turned off

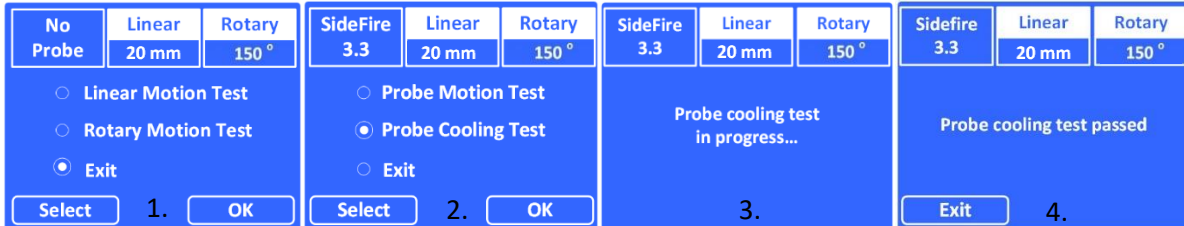

1. Press the blue Select button to highlight the *Exit* radio button and press the OK button
2. Press the blue Select button to highlight the *Probe Cooling Test* radio button and press the OK button to initiate
3. The Cooling Test will begin within 5 sec's as noted on the display (the LDP will be cooled in steps throughout the test). Wait for the test to complete
4. Use the Select button to Exit

Following a successful cooling test, the IP will be automatically powered down within 30 - 40 seconds.



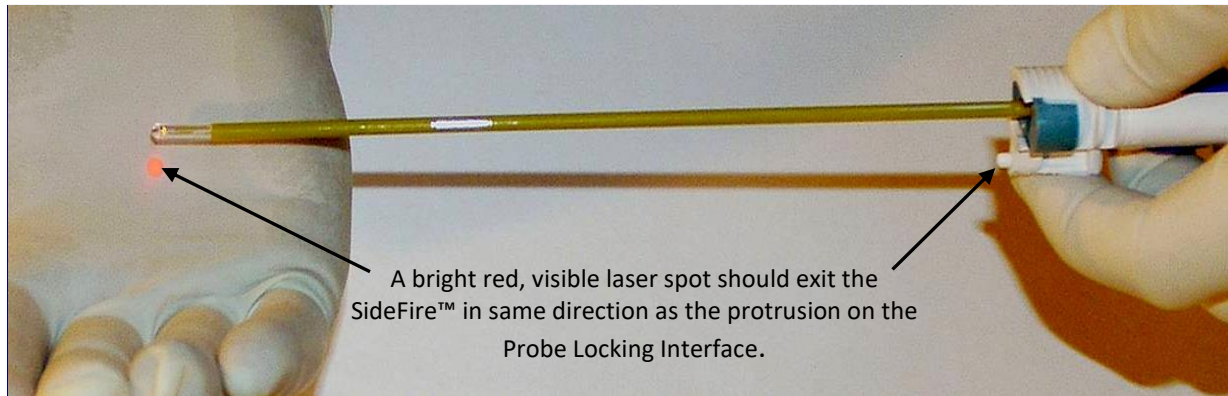

**Figure 8.6.31: Laser Aiming Beam Test - SideFire®**



**Figure 8.6.32: Laser Beam Test - FullFire®**

- Perform the Laser aiming beam test.
- The visible pilot laser provides a bright, red laser light exiting the LDP tip in the correct orientation from the LDP must be visible. Aiming the SideFire beam at a surgical glove should produce a bright, red spot (see Figure 8.39). The FullFire should exhibit a bright red light emanating from the effective focal area on the probe tip.

**Note:** If the user does not see a strong, visible red aiming laser beam exiting the SideFire Probe (Figure 8.6.31) tip or emanating from fiber tip within the FullFire probe tip’s clear capsule (Figure 8.6.32), ensure that LDP Laser Plug is fully inserted (two-clicks) into its connector on the IP Connector Module. If the connected probe doesn’t produce a red laser beam, disconnect the LDP and select a second LDP of the same size and configuration. Set the depth stop to the correct setting and repeat the Laser Aiming Beam Test. If a failure occurs again, contact Monteris service for diagnosis.



**WARNING:** A non-existent or weak visible laser beam may be an indication of an improperly connected laser fiber. If this condition occurs, **DO NOT CONTINUE** as it may result in equipment damage or injury to patient.

---

#### 8.6.4. Laser Delivery Probe (LDP) Insertion

---

Using the following steps, the sterile LDP can now be advanced into the RPD Follower and into the brain until the LDP Locking Interface comes in full contact with the Mating Adapter on the Follower (see Figure 8.6.41).



---

**CAUTION:** Ensure the desired LDP trajectory does not interfere with the MR bore or NeuroBlate equipment prior to the insertion of LDP into tissue.

---

**Note:** A treatment strategy should be determined during surgical pre-planning. A “top-down” treatment strategy can be considered starting at the proximal-most target location and ending at the distal-most location. Alternatively, a “bottom-up” approach may be more appropriate.



---

**CAUTION:** Final insertion to PDP should always be done by hand, under full user control where tactile feedback is important.

---



---

**WARNING:** Ensure there is a clear opening through the skull and dura to allow the probe to pass without resistance or trajectory deflection. Forcing the probe into the brain when resistance is felt can lead to Laser Probe tip fracture and result in patient injury.



**WARNING:** To prevent patient injury after LDP insertion, carefully monitor the Connector Module cable bundle during any movement of the MRI table and ensure there is adequate slack in the cable bundle to prevent strain being placed on the Connector Module.



**WARNING:** To prevent inadvertent linear movement of the Probe Driver Follower and potential patient injury, do not use excessive force during insertion and attachment of the LDP to the Probe Driver Follower.



**WARNING:** The 2.2 and 1.6 mm LDP's achieve target accuracy only if the pathway is first created to the target using an appropriately sized rigid probe, stylet or Monteris Alignment Mandrel.

---

### 8.6.4.1. Insertion of the 2.2 mm and 3.3 mm LDPs

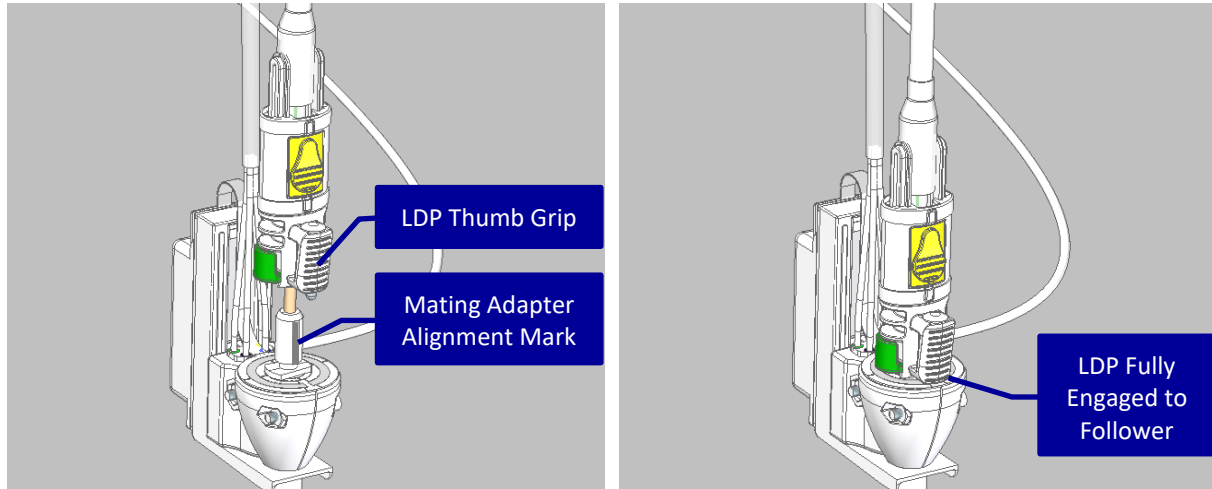

**Figure 8.6.41: Laser Delivery Probe as Inserted into the RPD Follower**



**Figure 8.6.42: Left: Correct LDP Insertion Technique; Right: Incorrect LDP Insertion Technique**

- Slowly insert the LDP through the Probe Driver Follower and visually align the LDP thumb grip to the alignment mark (grey line) on the Mating Adapter (Figure 8.6.41)
- Continue insertion until fully engaged to the Follower Mating Adapter and locked in position; an audible click will be heard



**WARNING:** To prevent inadvertent unlocking or slipping of the LDP Depth Stop during insertion, hold the LDP at the bottom-most portion of the Locking Interface while inserting into the brain as shown in Figure 8.6.42 to prevent potential injury.

- Ensure that the LDP is fully engaged to the Probe Driver Follower prior to manipulating LDP in tissue
- Confirm by gently pulling back on the LDP to ensure it is properly locked in place
- Insert the tip of the sterile LDP into the RPD Follower and into the brain until the LDP Locking Interface comes in contact with the Mating Adapter

### 8.6.4.2. Insertion of the NB3 1.6 mm LDP



**CAUTION:** It is required to insert the Monteris Alignment Mandrel to target depth through the Mini-Bolt following the instructions in Section 8.2.8 before attaching the probe driver and prior to laser probe insertion to ensure accurate placement of the NB3 probe.

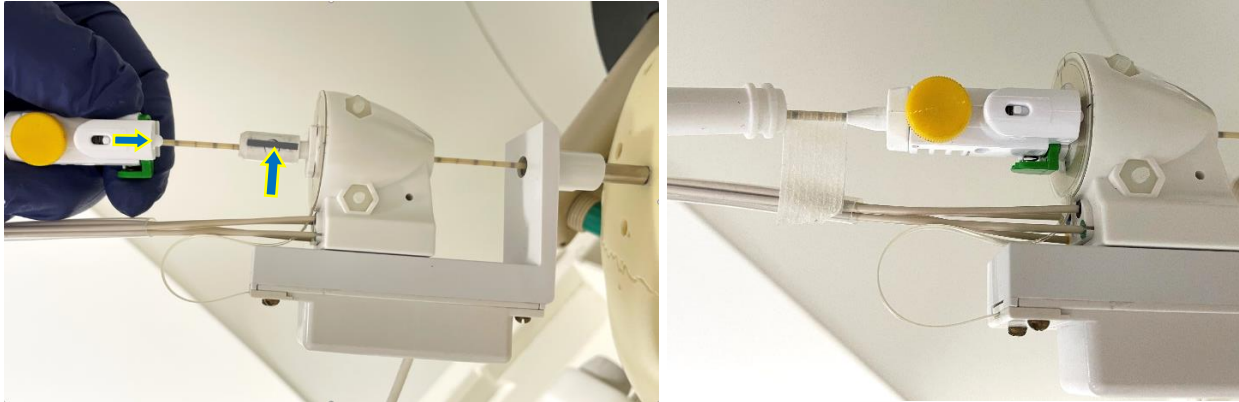
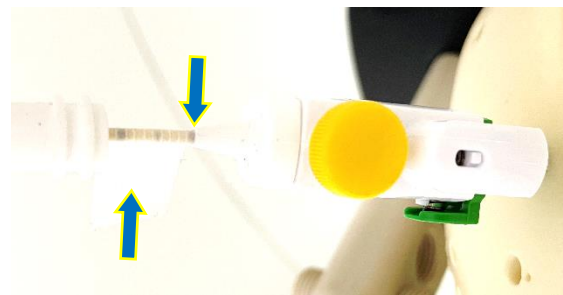

**Figure 8.6.43: Left: 1.6 mm LDP Insertion Right: LDP Fully Inserted**

- Slowly insert the 1.6 mm LDP through the Probe Driver Follower and visually align the protrusion at the bottom of the Floating Depth Stop under the yellow locking knob to the alignment mark (grey line) on the Mating Adapter (see arrows for Figure 8.6.43 Left)
- Continue insertion until fully engaged to the Follower Mating Adapter and locked in position; an audible click will be heard when engaged (Figure 8.6.43 Right)
- Ensure the LDP is fully engaged to the Mating Adapter prior to manipulating LDP in tissue
- Confirm by gently pulling back on the LDP to ensure it is properly locked in place

**Note for Manual Mode workflows (no RPD):**

- The LDP can be inserted directly through the Mini-Bolt
  - Ensure the Floating Depth Stop is set to the appropriate depth to achieve the desired PDP (see Figure 8.6.13)
  - The included Steri-Strips can be used to wrap around the LDP shaft at its exit of the depth stop as a visual reference when the probe tip is deployed to its deepest point if manual retraction of the LDP is required (see arrows above)
- Note:** The Steri-Strips cannot be removed once applied



**WARNING:** When using a Manual Mode workflow, the probe should not be excessively bent or placed at a significant distance from PCM.

---

## 8.7. INSERT TASK

---

Once the LDP has been inserted in the brain, its position must be identified on MR imaging as a means for defining the correct trajectory within Fusion-S Software. A new, volumetric MRI scan must be acquired to identify the LDP signal void. In the *Insert* task a new and valid probe trajectory is created. For the SideFire Probe, laser beam directionality is also determined in this task.



---

**WARNING:** Insertion of the LDP must be confirmed using MRI guidance to ensure accurate probe placement. This must be followed by adjustment of the software rendered LDP to match the LDP void shown. Failure to complete the procedure steps may result in improperly positioned thermal monitoring with respect to laser exit position, potentially leading to patient injury.

---

### 8.7.1. Probe Placement MRI

---

- Acquire a volumetric MRI sequence of the entire head to include the applied fiducial marker on the lower bracket of the probe driver for the SideFire



---

**CAUTION:** For Siemens/IMRIS MRI, 2D Distortion Correction must be enabled in the sequence protocol to reduce possible image distortion. DO NOT use 3D Distortion Correction This protocol factor resides in the **Resolution** section under the **Filter** tab.

---

- Return to the *Registration* task and push image data to Fusion-S Software
- If pre-op imaging has already been loaded, right click on the probe placement thumbnail view and select *Set as Master*
- Co-register the probe placement scan with any prior planning sequences loaded into the system

**MR Image Guidance Note:** Although probe insertion can be monitored on the MR console, appropriate images can be sent to the software to load into the views in order to compare the probe void evident during insertion with expected final probe linear position rendered in the software. The measurement tool is useful to quantify the progress of insertion.

**MR Image Sequences:** Fast Spin Echo sequences are optimal for minimal probe void distortion. 3D Gradient Echo sequences are also acceptable but may slightly exaggerate the size of the probe. If possible, set the frequency encode direction opposite of parallel (anti-parallel) to the probe. Imaging should be executed on the MRI only when linear or rotary probe motion is NOT active

### 8.7.2. Software Rendered Probe to Actual Probe Position Match

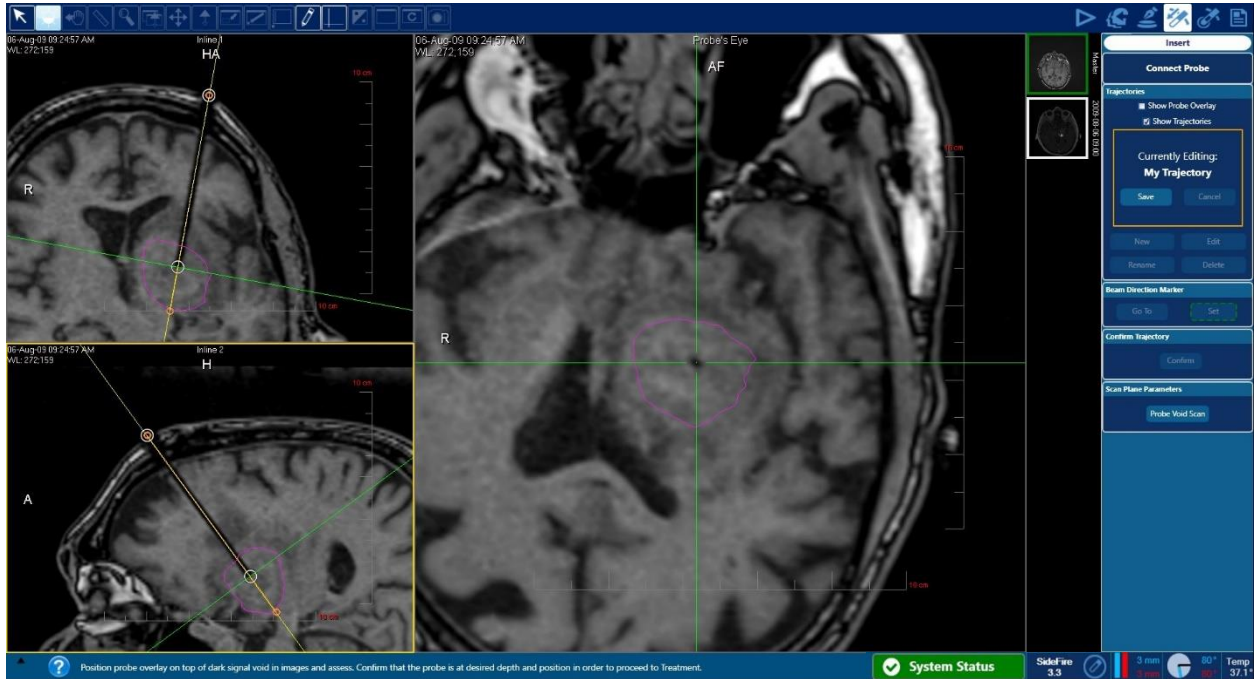
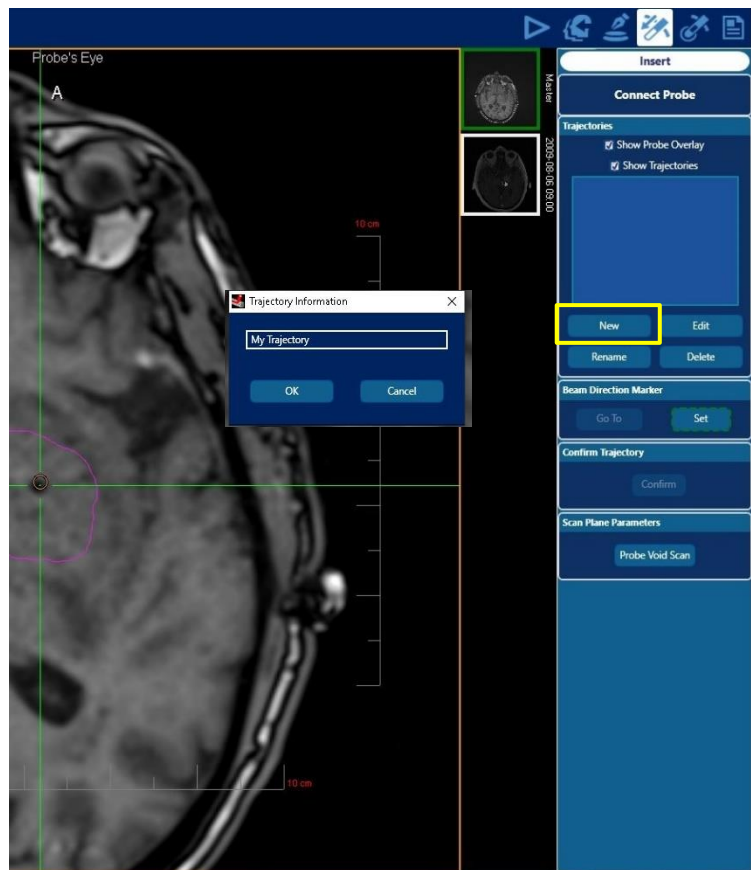

**Figure 8.7.21: Trajectory Matching to Probe Artifact**

- Select the *New* icon in the right-side screen menu (yellow box image right)
- Rename the new trajectory as desired in the pop-up dialog box and click *OK*
- Adjust the trajectory manipulating the white grab handles to match to the LDP void on the acquired image (see Figure 8.7.21 top)

**Note:** *Show Probe Overlay* is unchecked in the example in Figure 8.7.21

- To create additional trajectories, click *New* in the right-side menu - move the grab handles to the desired entry and target



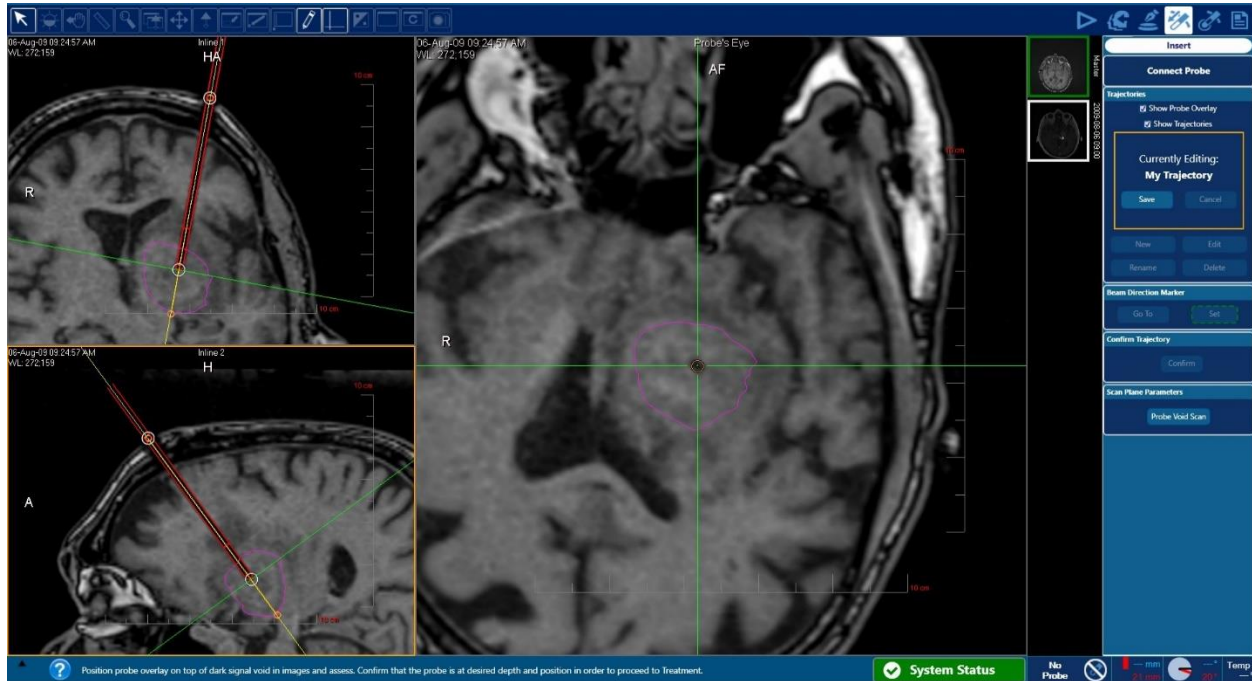

**Figure 8.7.22: Software Rendered Probe**

- With the Show Probe Overlay box checked, ensure the red, software rendered probe is aligned and superimposed over the probe artifact
- When the software rendered LDP image matches the LDP artifact on the screen, click Save under the heading “Currently Editing” in the right screen menu

**Probe Depth:** If the actual probe depth position within the tissue as shown by the probe signal void is deemed to be at an ideal location, but it does not align with software rendered probe, adjust the depth position.

If the probe void is difficult to identify due to an existing void created from a biopsy needle, the measurement tool can be used to measure the expected distance from the outer table of the skull to the probe tip.

If Manual Probe Movement was selected at the Fusion-Start task (manual mode), an additional Probe Confirmation header will be visible in the right-side menu (image right). The user must confirm that the Linear and Rotary readings displayed in the probe status bar (lower right corner of software GUI) match the physical position and orientation of the Laser Delivery Probe in the brain. If a match is confirmed, the user must select the Confirm Linear and Confirm Rotary icons before selecting Confirm under Confirm Trajectory. Select OK in the dialog box to complete the confirmation for each.

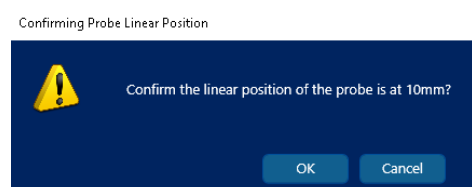
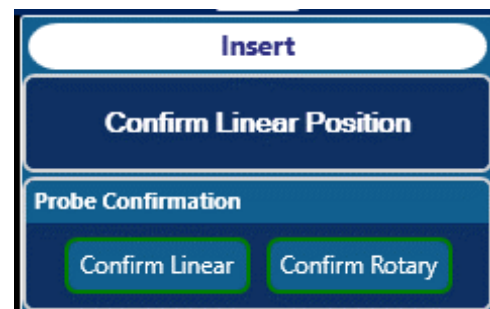

### 8.7.3. SideFire Probe Beam Direction

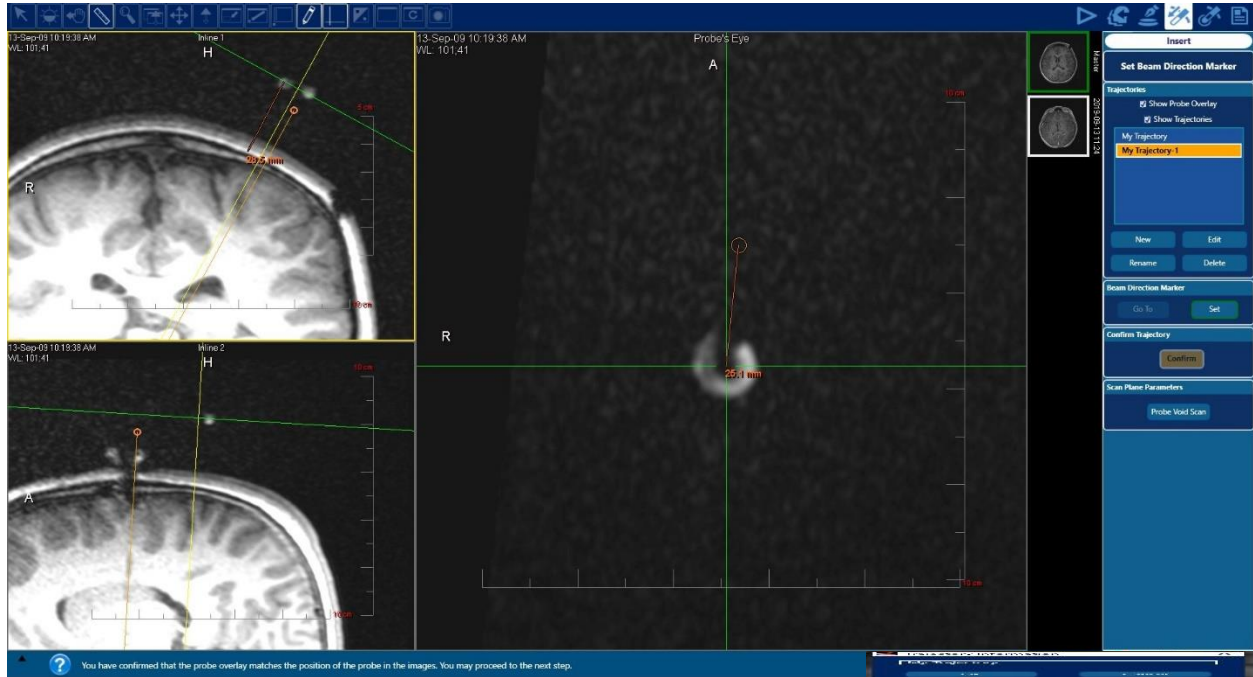

**Figure 8.7.3: Beam Directional Marker (SideFire LDP only)**

- Click and drag the navigation lines (green and yellow crosshairs above) to locate the center of the fiducial marker if applied to the RPD follower.

**Note:** With use of a donut-style marker, the marker center is typically 25 mm from the center of the trajectory in the Probe’s Eye view and roughly 28 mm from the skull surface in the inline views (see measurements in Figure 8.7.3)

- Drag the crosshair of the navigation lines over the center of the fiducial marker’s “donut hole”
- Click the Set icon under the Beam Direction Marker heading in the right screen menu

If a fiducial marker was not applied to the RPD, orient the Beam Direction Marker in the same direction as the back side of the RPD Follower as shown in Figure 8.52.

**Note:** This step is not required if a FullFire probe is used



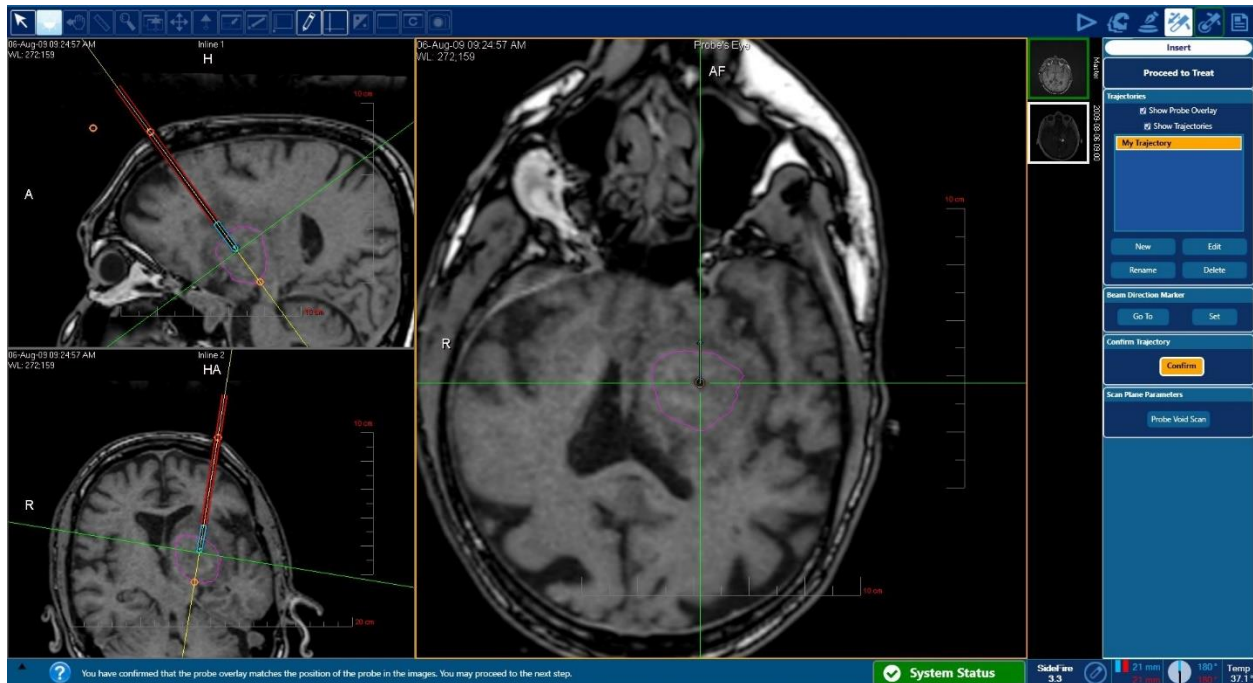

**Figure 8.7.4: Confirm Trajectory**

- Once the Beam Direction Marker is set, the Confirm icon in the right menu under the heading Confirm Trajectory is enabled
- Click the Confirm icon and the software is ready to move to the Treat

Note that once the trajectory is confirmed, the tip of the software rendered probe capsule will turn to blue enabling the user to robotically manipulate the linear position of the LDP (see Figure 8.7.4).

### 8.7.4. Acquire Probe Void Scan (GE MRI only)

Unlike Siemens or Philips MRIs, GE MRI systems do not use simple data entry to setup the active perpendicular slice planes for thermal ablation. Setup of these planes is done through a process of scans and manual alignment of the scan planes/scan range on the GE console (called the “prescription”). The Probe Void Scan is the initial step of thermal sequence prescription when using a GE MRI.

- The prescription must be performed once per trajectory to setup the available 13 slices for thermal imaging in every case
  - This process is required to be performed at least once per case (based on number of trajectories)
  - First, you must prepare the GE console for Real-time transfer
    - a. Follow ‘QRG – Real-time Transfer Activation
1. Ensure you have selected Confirm under Confirm Trajectory
  2. Under *Scan Plane Parameters* heading in the right screen Fusion menu, select *Probe Void Scan* icon

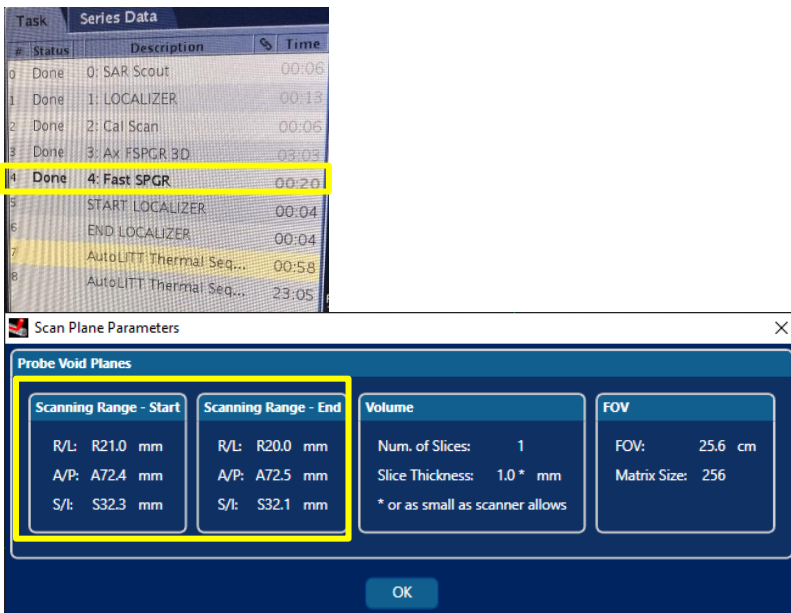

3. Open the FSPGR (or Fast SPGR) scan from the Monteris protocol
4. Type the numbers printed in the *Scan Plane Parameters* pop-up dialog window to the *Position* section of the FSPGR sequence on the GE MRI
5. Run the sequence protocols
  - Enter start and end coordinates using Probe Void Scan parameters
  - Set #Slices to 1
  - Set slice thickness to 5.0 mm
6. Acquire the Probe Void Scan

### 8.8. THERMAL DELIVERY AND MONITORING IN TREAT WORKFLOW TASK

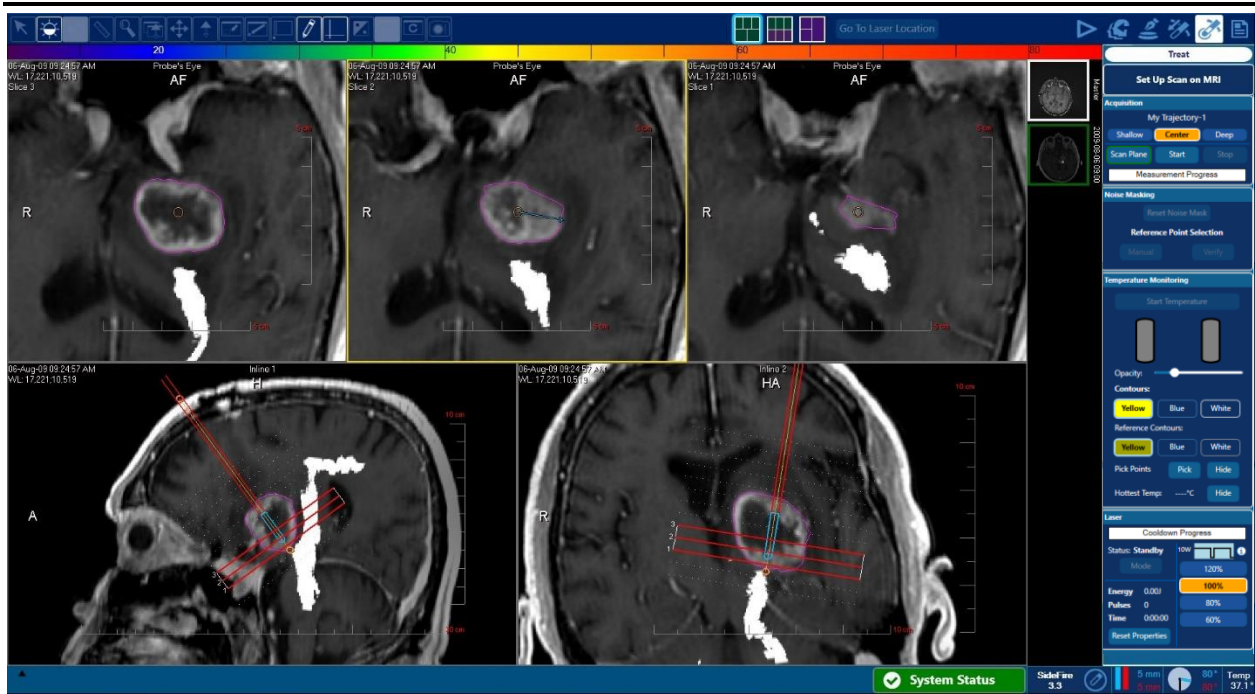

**Figure 8.8: Treat Workflow Task**

The user may now proceed to the Fusion-S *Treat* workflow task for thermal delivery.



**WARNING:** To prevent ablation of unintended tissue, the user shall visually confirm that all created volume contours and trajectories are properly displayed with respect to the patient’s anatomy within the *Treat* workflow task image view panes. This applies to the image dataset set as Master as well as any co-registered image data sets displayed as background imaging during thermal delivery.

**NOTE:** Tissue thermal interactions (such as coagulation) are not governed by the temperature of the tissue alone. The duration for which the tissue is exposed to any given temperature is also of critical consequence. The NeuroBlate System uses non-invasive, near real time MRI thermometry to monitor temperature change and duration. Together, temperature and duration are used to calculate a thermal dose which is defined by the boundary line as expressed in the thermographic analysis software.

**NOTE:** If multiple patient procedures are done in a single day, the laser properties must be reset to 0 for the next case through a power cycle, or by selecting the *Reset Properties* icon in the Treat task Laser menu (image right).

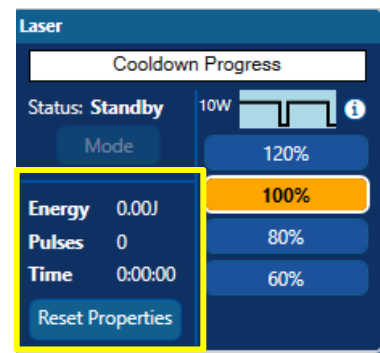

### 8.8.1. Enable the MRI for Real Time Transfer

#### Siemens or IMRIS MRI

#### Special Instruction for Siemens Access-i

On the MRI console, ensure that Access-i is active. Click to change from inactive to active. **Note:** the icons shown below may vary.

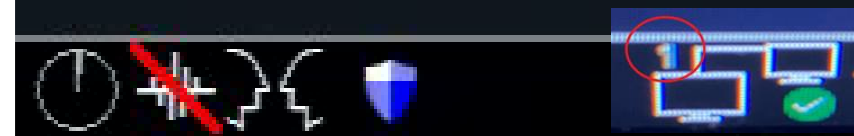
	<p>Inactive</p>
	<p>Active</p>

While the remote control is active on Access-i, access from the client is enabled. The number of connected clients is shown in the upper-left corner of the icon. Ensure that only the NeuroBlate System is connected during thermal monitoring. Refer to the Siemens Access-i user manual for more details.

The MRI System Status on the Fusion-S start screen can also be used to verify Access-i is connected.

Proceed to step **8.8.2 - Position Thermal Monitoring Planes in Fusion-S**

#### Special Instruction for Siemens Online Export (IDEA Command Tool)

Prior to thermal delivery and monitoring, the data transfer interface for any Siemens MRI must be enabled following patient registration and immediately preceding thermal monitoring. **Note:** The MRI system will revert to the default configuration at the end of the NeuroBlate procedure.



**CAUTION:** Do not enable the real time data transfer interface prior to this point in the workflow. To prevent unintended application exit of the host MRI system control software.

- In Advanced User Mode, Launch Command Tool Shell and Enable Data Transfer

Type: **Ctrl/Esc**

Select: *Run*

Type: **cmd** and click *OK*

Type: **ideacmdtool**<enter>

Type: **5** (*Switches...*)

- Type in the site-specific password if requested. The “Switches” Menu should appear in its default mode as shown in Figure 8.8.10:

```

Please enter number or unique text of a cmd. (<'q' for quit>)
> 5

Switches Menu
-----
 1. SeqDumpMode           OFF   [OFF, ONCE, Perm]
 2. SeqDebugMask          0x0
 3. PhaseEncoding         ON
 4. MeasData2Disk         OFF
 5. SingleThreaded_Calculation OFF
 6. Empty_ICEProgram      OFF
 7. Empty_Adjustment_ICEProgram OFF
 8. SendIMA               OFF
 9. SendRAW               OFF
10. SendRHP               OFF
11. SendMeasData          OFF
12. SendBuffered          ON

Please enter number or unique text of a cmd. (<'q' for quit>)
Switches> _
  
```

**Figure 8.8.10: IDEA Command Tool Switches Menu (on MR host PC)**

- At the *Switches*> prompt, Type: **8** and then *Enter*
  - This toggles the *SendIMA* Switches from OFF to ON
- At the *Switches*> prompt, type: **12** and then *Enter*
  - This toggles the *SendBuffered* from ON to OFF
- The *Switches Menu* shown in for items 8. - 12. shown in Figure 8.44 should now read:

```

 8. SendIMA               ON
 9. SendRAW               OFF
10. SendRHP               OFF
11. SendMeasData          OFF
12. SendBuffered          OFF
  
```



**CAUTION:** Do not modify any other settings within menus, including (*Switches*)menu.

- Type: q (to exit *Switches Menu*)
- Type: q (to exit *ideacmdtool*)



**CAUTION:** For Siemens MRI software version 19, the values for the *Switches Menu* should be reset to their original values at the end of the NeuroBlate procedure following the same procedure outlined on pages 105 – 106 to prevent suspending the MRI software requiring an MRI system reboot to clear.

---

**Special Instruction for Siemens Aera/Skyra Online Export Software VD13; VE11 or higher**

---

**Note:** this section does not apply to Access-i

Before real time data transfer begins, the Siemens MRI must be disconnected from the PACS network and directly connected to the NeuroBlate Main PC forming a direct peer-to-peer network connection. In this case, both the NeuroBlate system and the Siemens MRI will be disconnected from the hospital PACS network temporarily during treatment monitoring. The MRI connection to the PACS network can be restored following treatment monitoring once real time data transfer is no longer necessary. This step can occur before the case begins or just before treatment monitoring since it will not disrupt normal DICOM data transfer between the MRI and NeuroBlate.

Proceed to step **8.8.2 – Position Thermal Monitoring Planes in Fusion-S**

---

**Special Instruction for GE MRI running software v15.x or higher only:**

---

- Check if **SVAT hosts** is activated
  1. Open a Command Window (TOOLS Icon Dropdown Menu-> Command Window)
  2. Type '**cd /w/config**' then press Enter
  3. Type '**ls svat\_hosts.cfg\***' then press Enter
  4. The following should be displayed:

```
{sdc@MR3R_SUNB}[99] cd /w/config
{sdc@MR3R_SUNB}[100] ls svat_hosts.cfg*
svat_hosts.cfg*
```

**Note:** If 'svat\_hosts.cfg.inactive' appears, the host is inactive. Type 'mv svat\_hosts.cfg.inactive svat\_hosts.cfg' in the command window, then press Enter. Check if SVAT host has become active by repeating steps 1 - 4 above.

5. In the command window, type '**cat svat\_hosts.cfg**' then press Enter to display the contents of the file
6. The following should be displayed:

```
{sdc@MR3R_SUNB}[101] cat svat_hosts.cfg
10.0.1.10 5BCD15
```

- Check if ILT server is already enabled
  1. Open a Command Window (TOOLS Icon Dropdown Menu-> Command Window)
  2. Type '`cd /w/init`' then press Enter
  3. Type '`ls ilt.init*`' then press Enter
  4. The following should be displayed:

```
{sdc@MR3R_SUNB}[101] cd /w/init/  
{sdc@MR3R_SUNB}[102] ls ilt.init*  
ilt.init
```

**Note:** If '`ilt.init.inactive`' appears, the server is inactive. Type '`mv ilt.init.inactive ilt.init`' in the command window, then press Enter. Check if ILT server has become enabled by repeating steps 1 - 4 above.

Check if LAIS server is already enabled

1. Open a Command Window (TOOLS Icon Dropdown Menu-> Command Window)
2. Type '`cd /w/init`' then press Enter
3. Type '`ls lais.init*`' then press Enter
4. The following should be displayed:

```
{sdc@MR3R_SUNB}[103] cd /w/init  
{sdc@MR3R_SUNB}[104] ls lais.init*  
lais.init
```

**Note:** If '`lais.init.inactive`' appears, the server is inactive. Type '`mv lais.init.inactive lais.init`' in the command window, then press *Enter*. Check if LAIS server has become enabled by repeating steps 1 - 4 above

- If SVT Host, ILT server, or LAIS server were initially inactive, a reboot is required.
  1. Click *Tools* Icon
  2. Click on Service Desktop Manager page
  3. Click System Restart to restart the scanner
  4. This will take 5-10 minutes. When prompted to log in as the system reboots, enter the following username/password:
    - Username: sdc
    - Password: adc2.0**Note:** All three files (`svat_hosts.cfg`, `ilt.init`, and `lais.init`) must be correctly configured to set CVs remotely.
- Check if LAIS is running properly:
  1. Open a Command Window (TOOLS Icon Dropdown Menu-> Command Window)

2. Type '**pgrep lais**' then press Enter
3. Ensure that there are two processes running:

```
{sdc@MR3R_SUNB}[106] pgrep lais
19953
14253
```

- If LAIS is not properly running (0 or 1 active process), manually restart LAIS:
  1. Open a Command Window (TOOLS Icon Dropdown Menu-> Command Window)
  2. Type '**killall lais**' then press Enter
  3. Wait one or two minutes
  4. Type '**pgrep lais**' then press Enter
  5. Ensure no processes are running:

```
{sdc@MR3R_SUNB}[108] killall lais
{sdc@MR3R_SUNB}[109] pgrep lais
```

6. Type '**setenv LAIS\_ENABLE\_ALL\_CMDS\_YES**' then press Enter
7. Wait 3 minutes then type '**lais &**' then press Enter

```
{sdc@MR3R_SUNB}[108] killall lais
{sdc@MR3R_SUNB}[109] pgrep lais
{sdc@MR3R_SUNB}[110] setenv LAIS_ENABLE_ALL_CMDS YES
{sdc@MR3R_SUNB}[111] lais &
```

8. Type '**pgrep lais**' then press Enter
9. Ensure there are now two processes running:

```
{sdc@MR3R_SUNB}[106] pgrep lais
19953
14253
```



---

**Special Instruction for all GE MRI's:**

---

- Acquire the *Calibration Scan* from the Monteris protocol list on MR user interface to enable ASSET.
  - Use the default scan parameters
  - Prescribe enough axial slices to cover the entire field of view to be imaged during thermometry (e.g., 50 slices x 6 mm slice thickness = 30 cm of coverage).
  - This scan is no longer required to be run separately for v27 and above but is now embedded into any scan. ASSET must remain enabled for thermal scans.

**Note:** If any of the imaging protocols are setup using the “Zoom” setting (options are either Zoom or Wide), it is recommended to switch and save the protocol set to “Wide”. The “Zoom” setting can be an issue when using the AtamA as the patient’s head is positioned higher in the bore and thus farther out of the magnet isocenter. When the probe is a certain distance beyond isocenter, the zoom setting will prevent the scan sequence from being started. The error message displayed does not make it clear that the “Zoom” setting is the issue.

---

**Special Instruction for Philips MRI regarding LAN connectivity**

---

Before real time data transfer begins, the Philips MRI must be disconnected from the PACS or Hospital network and directly connected to the NeuroBlate Main PC forming a direct peer-to-peer network connection. In this case, both the NeuroBlate system and the Philips MRI will be disconnected from the hospital PACS network during treatment monitoring. The MRI connection to the PACS network can be restored following treatment monitoring once real time data transfer is no longer necessary. This step will not disrupt normal DICOM data transfer between the MRI and NeuroBlate. There is no special configuration of the Philips MR software is required to enable real time data transfer. Any configuration required is completed during installation of the NeuroBlate system and no further software configuration is needed prior to any case.

### 8.8.2. Position Thermal Monitoring Planes in Fusion-S

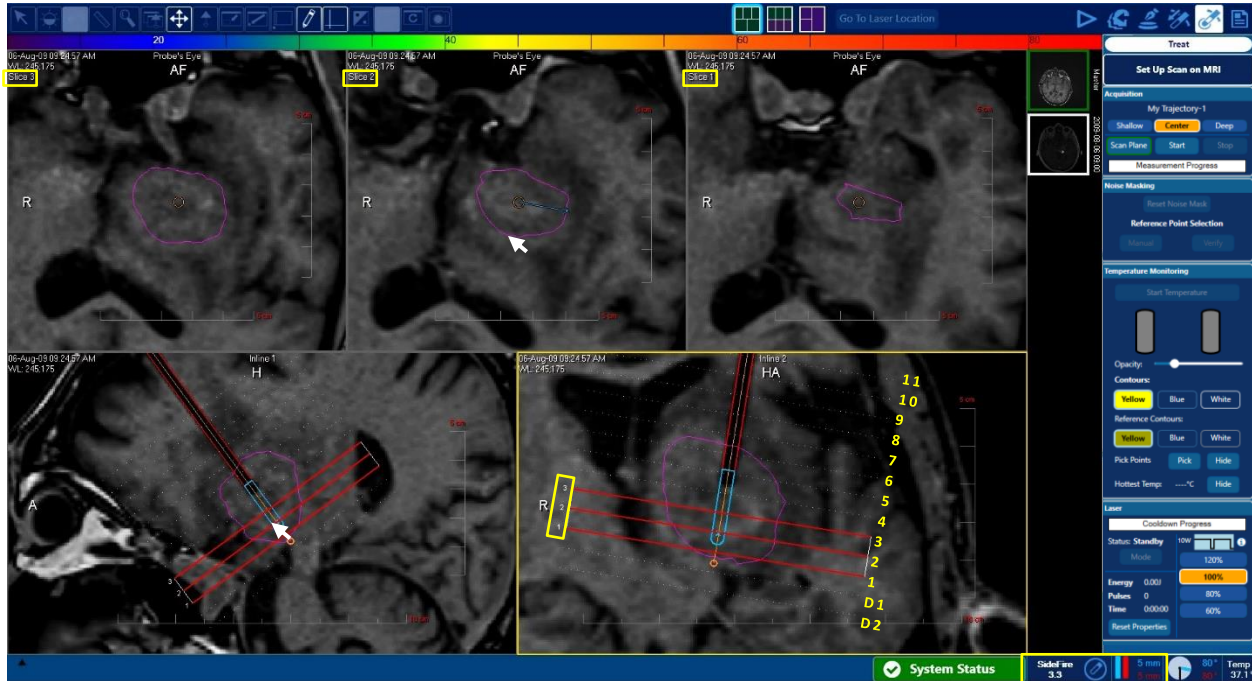

**Figure 8.8.1: Adjustment of LDP Linear Position**

- Use the white cursor arrow to adjust the software rendered LDP depth by clicking on and dragging light blue capsule at the distal end of the software rendered probe to the desired linear position for thermal delivery (Figure 8.8.1)

As the target LDP position is adjusted by the user, the position is indicated in the Probe Dialog on right of screen.



- Adjust the software rendered LDP rotary position to the desired direction (angle) for thermal delivery by clicking and dragging the beam direction line (Figure 8.8.1) - rotary position adjustment for the FullFire LDP is NOT required since it has no impact on laser energy emission

A software dialog box will appear asking the user to confirm movement of the LDP to the desired location. If the user selects OK, the RPD (if applicable) will move the LDP to the location selected.



As the software rendered probe adjusts on the screen, the three active thermal monitoring planes will adjust to stay centered over the laser exit position on the probe (the X on the software rendered probe). The active slice plane numbering corresponds to the slice numbers displayed in the upper left-hand corner of each of the three view upper view panes (see yellow boxes in Figure 8.8.1).

If manual probe motion was initially selected (see Sec 8.1), the user must enter MRI suite and physically manipulate probe position to match target setting.

- Select the *Confirm Rotary or Confirm Linear* button under the *Probe Confirmation* heading shown right - this immediately adjusts the Actual position to match the target position when the RPD is not in use to provide position feedback

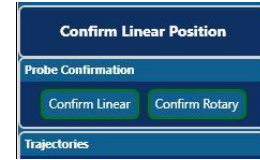

**Note:** For FullFire probes in software version (SW) v3.18, only the *Confirm Linear* button is visible (image above)

Following any probe rotary or linear position manipulation, it may be desirable to shift the monitoring planes to position the laser exit in a slice other than the center slice (the default). In many situations, temperature elevations do not occur in slices proximal to the beam exit position. However, temperature increases can occur in one and even two slices distal to the beam exit position depending on how long the laser shot occurs. Therefore, the monitoring slices can be adjusted for this purpose.

The adjustment is limited such that the beam exit position lies between the midpoint of the proximal and distal slice of the three-slice monitoring view.

The three slice plane lines shown above (red arrow) indicate the location of the MR thermometry monitoring planes relative to the probe tip position. These can be adjusted from the buttons within the *Monitoring Preference* area.

*Center:* Aligns slice planes centered on laser exit position.

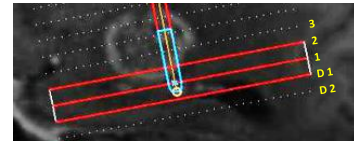

*Deep:* Aligns slice planes distal to laser exit position.

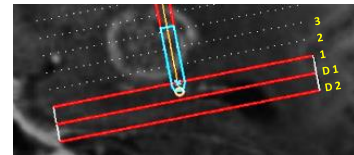

*Shallow:* Aligns slice planes proximal to laser exit.

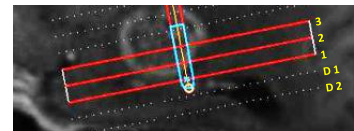



**WARNING:** If at any point in the procedure it's observed that the Software Rendered Probe's linear position or rotary orientation changes without user input, the Robotic Probe Driver (RPD) should be visually inspected to confirm if its actual linear and rotation match the values reported by the software. If a mismatch is noted, this is an indication that the position sensors in the RPD are faulty. If this situation occurs, to prevent potential patient injury the RPD should either be replaced or only be used in Manual Mode without robotic assistance.



**WARNING:** If the patient head position changes relative to the head fixation device or the initial MRI position set during the landmark procedure at any point during the NeuroBlate procedure, the entire head must be re-scanned using a 3D volumetric scan. This scan must be set as the master series with all other scans co-registered to the new master series. Failure to reset master series may result in thermal dose delivery to an unintended area potentially causing patient injury.

---

### 8.8.3. Thermal Sequence Prescription on the MRI



**CAUTION: MR Thermometry Data.** The MR data must use the *NeuroBlate System* defined sequence parameters for temperature measurement. This includes use of a specific GRE sequence(s) preinstalled on the target MRI system. The only modifications allowed are position, orientation, flip angle, and phase encode direction depending on the location. Failure conditions will result if parameters are changed or the position/orientation is not aligned with the required treatment planes. If in-plane panning is required, the FOV must include the treatment areas. Careful attention must be made so that in plane panning is done correctly and the resulting acquisition plane is still aligned with the prescribed treatment planes. FOV position adjustment (in plane panning) can only be made for the first treatment slice. Thereafter, the software shall lock onto the 4 corner positions of the images and only allow images along the probe trajectory aligned to these.

#### Siemens or IMRIS MRI

- Select the Scan Plane icon under the Monitoring Preferences heading from the right-side menu in the Treat workflow task
- Enter the displayed scan plane geometry parameters for the thermometry sequence protocol into MRI control software prior to starting the thermometry scan

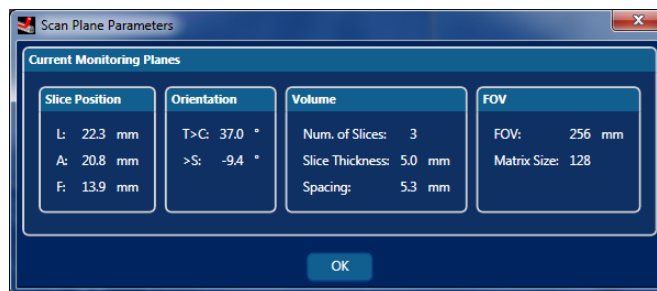

**Figure 8.8.2: Scan Plane Parameters for Siemens or IMRIS MRI**

- Select the Scan Plane under the Monitoring Preferences on the Fusion the right menu bar.
  - Cue the *NeuroBlate Thermal Monitoring Sequence* from the MRI system’s sequence protocol list. Select Standard or Fast variants of this sequence in list as desired.  
Note: In SW v3.18 the Thermal Sequence is renamed to *NeuroBlate Thermal Seq (GRE)*
  - Enter the displayed scan plane parameters into the NeuroBlate Thermal Monitoring Sequences protocol’s geometry parameters in the MRI.

For Siemens or IMRIS MRI, proceed to step **8.8.4 Initiate Thermal Monitoring in Fusion-S.**

### 8.8.3.1. GE Thermal Sequence Prescription Procedure

Continuation from Step #6 in Section 8.7.4 (Acquire Probe Void Scan on GE):

- Enter Treat task within Fusion-S Software and select *Scan Plane* from the task menu

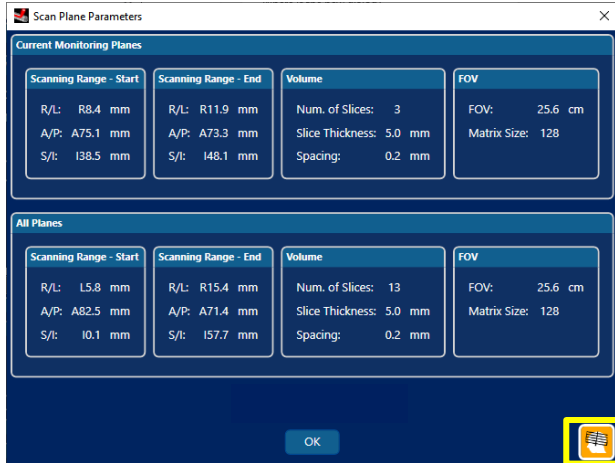

Task #	Status	Description	Time
0	Done	0: SAR Scout	00:06
1	Done	1: LOCALIZER	00:13
2	Done	2: Cal Scan	00:06
3	Done	3: Ax FSPGR 3D	03:03
4	Done	4: Fast SPGR	00:20
5		START LOCALIZER	00:04
6		END LOCALIZER	00:04
7		AutoLITT Thermal Seq...	00:58
8		AutoLITT Thermal Seq...	23:05

- Select *Show All Planes* in the pop-up dialog window to display as shown above left

- Open the *AutoLITT (or NeuroBlate) Thermal Seq (GRE)* in the Monteris protocols on the GE MRI (image above right)

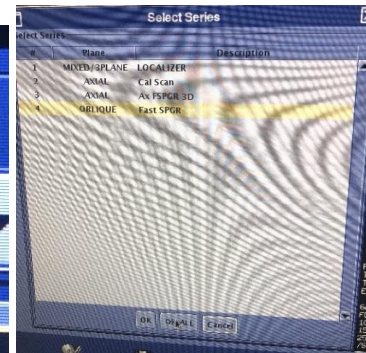

- From the Graphic RX toolbar, click the 'Select Series' icon (above left)

- Select the FSPGR scan run in step 3 and select OK ALL (above right)

- FSPGR is now loaded into the view - probe view should be shown on MRI (image right)

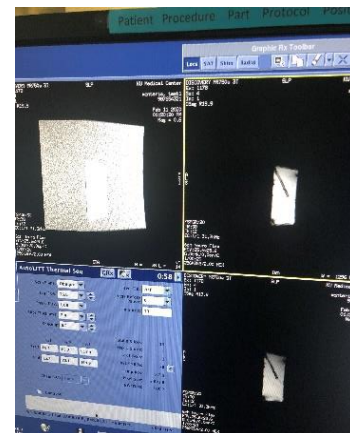

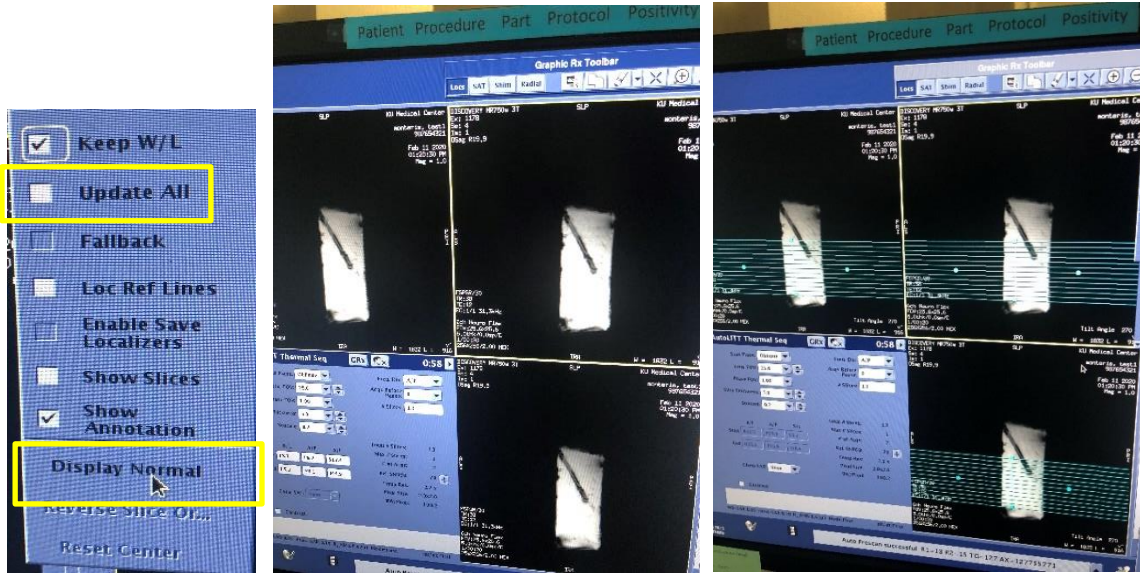

15. Adjust viewing options



- Select the *Arrow* icon  on the *Graphic RX Toolbar*
- Ensure *Update All* is not checked
- Click *Display Normal* and *Erase All*
- All windows should now show the probe void (above middle)
- If not already 13 slices in the protocol, change the number of slices to 13

16. Click in the image - there should be a 13-slice stack displayed (above right)

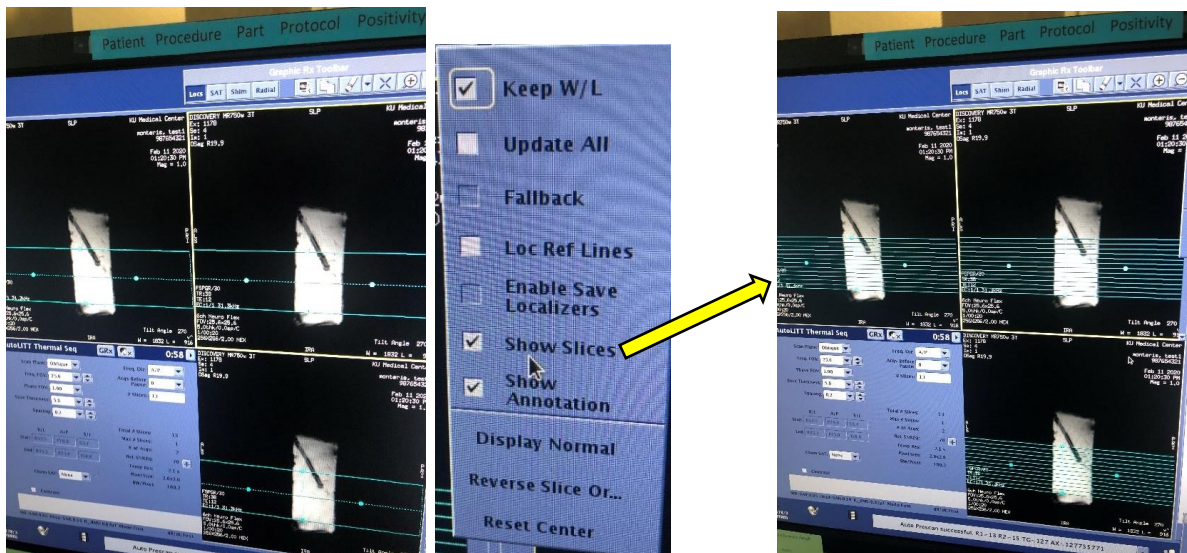

Note: If a single rectangle is displayed (rather than the 13 slices) all slices can be shown by:

- Selecting the *Arrow* icon  in the *Graphic RX toolbar*
- Select *Show Slices*

17. Rotate and pan the stack so that the single vertical line in the center of the stack aligns with the probe void

- To Rotate: grab using the two blue circles
- To Pan: click the center vertical line and drag the stack

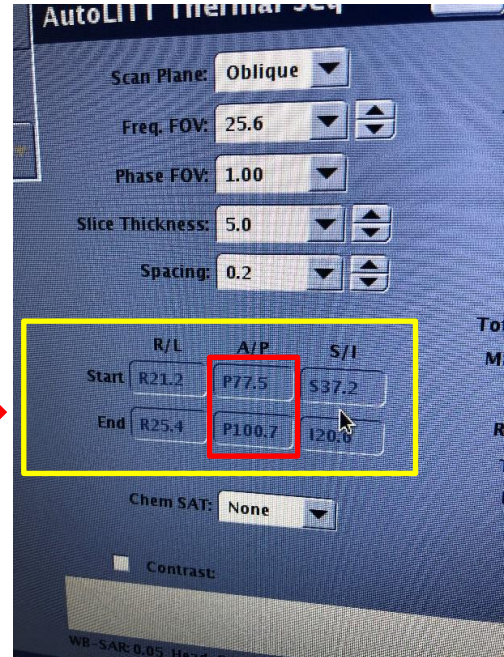
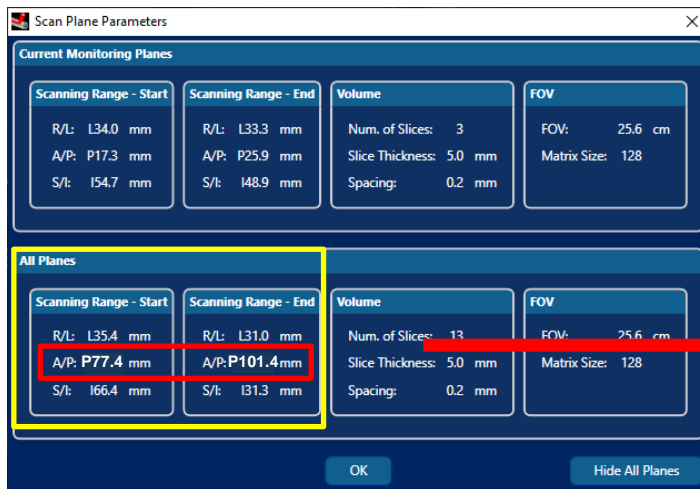
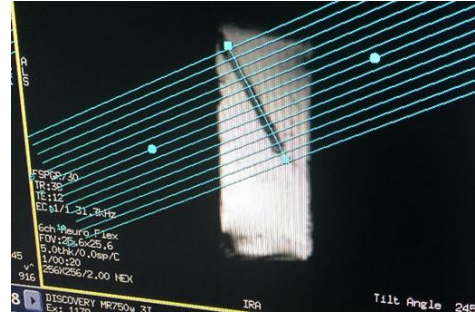

18. Fine-tune the stack

- Use the parameters from Fusion-S *Scan Plane Parameters* (All Planes)
- adjust the stack along the probe void so that the GE position values of the “proper plane” match Fusion-S parameters within 2.0 mm in both Start and End points (*All Planes*):

**Note:** the “proper plane” will be case dependent based on the laser probe trajectory. For example, in an MTS/MTLE case, with a posterior entry point targeting the hippocampus, the proper plane will be A/P (see example above). For a trajectory coming from the top of the head (ex: hypothalamic hamartoma), the proper plane will be S/I. A trajectory coming in from the side of the head (temporal), the proper plane will be R/L. You do not need to be concerned with the other four values.

This also assumes that the patient anatomy is lined up in “normal” orientation on the GE console and Fusion-S (on the Axial image, nose faces 12 o’clock position)



If it is not, then the “proper plane” will be different. The “proper plane” to look for is the MRI coordinate plane, not the patient. See examples below:



Patient aligned “normally”; proper plane to align is A-P



Patient aligned rotated 90 degrees; proper plane to align is R-L

19. Set phases to 2 within Multi-Phase
20. Set Acceleration to 1
21. Run the AutoLITT (or NeuroBlate) Thermal Sequence, 13-slice scan
  - after this scan has started, it can be stopped prior to completion
22. Right-click on AutoLITT (or NeuroBlate) Thermal Sequence, select Duplicate & Setup
  - Change the number of slices to 3 by grabbing the center square at either the top or bottom of the stack and dragging up or down
 

**Note:** Ensure the desired 3 slice planes are prescribed within 2 mm in the GE user interface by comparing the Start and End Point Parameters within Fusion’s current acquisition planes in the *Scan Plane Parameter* dialog with the geometric scan plan parameters displayed on the GE user interface. As in the example from step 17, above, only the value of the “proper plane” needs to match; do not be concerned about the other two coordinate values
  - Change *Number of Phases* to 170 (maximum)



**CAUTION:** GE only allows for a maximum of 170 thermal measurements which allows for a maximum of ~23 minutes of thermal delivery before the MRI thermal sequence and thermal monitoring within Fusion-S must be restarted.

23. Select Save Series (v15 - 19) or Save RX (v20 and up) then download the sequence
24. For GE v15 - v19: select Prep Scan
  - For GE v20 and up select the dropdown arrow within the Scan icon on the GE user interface and select *Auto Pre-Scan*

25. Select Start Acquisition within Fusion-S  
- Verify message dialog appears on MRI stating that CV parameters are set (image right)



26. Select the Scan icon in the GE user interface which triggers the acquisition

27. Proceed with thermal monitoring in the Fusion-S Treat workflow step

28. To continue with thermal delivery in different slice planes, repeat Steps 22-28, moving the stack up or down as needed, comparing the parameters with the Fusion-S displayed Start and End Point parameters



**CAUTION:** *Auto Pre-Scan* must be initiated before proceeding to *Start Acquisition* to prevent an error condition which will not allow thermal monitoring to proceed.

### 8.8.3.2. Philips MRI Thermal Sequence Prescription Procedure

- Proceed to the *Treat* workflow task in Fusion-S
- Philips requires a 2 step scan process to accomplish real time thermal data transfer - his process must be followed for any new thermal MR acquisition for Fusion-S

**Step 1 “Header Scan”:** To begin any new thermal acquisition, step 1 requires first loading and preparing the *NeuroBlate Thermal Monitoring Sequence* from the MRI system’s sequence protocol list. It will be labeled *AutoLITT (or NeuroBlate) Thermal Seq (GRE)*

- Ensure the thermal sequence is properly configured to accomplish Step 1:  
Dyn scans = 1 (Set in the Dyn/Ang tab)

- Select the *Scan Plane* icon under the Monitoring Preferences heading on the right menu
- Enter the displayed scan plane geometry parameters for the thermometry sequence protocol into MRI control software prior to starting the thermometry scan

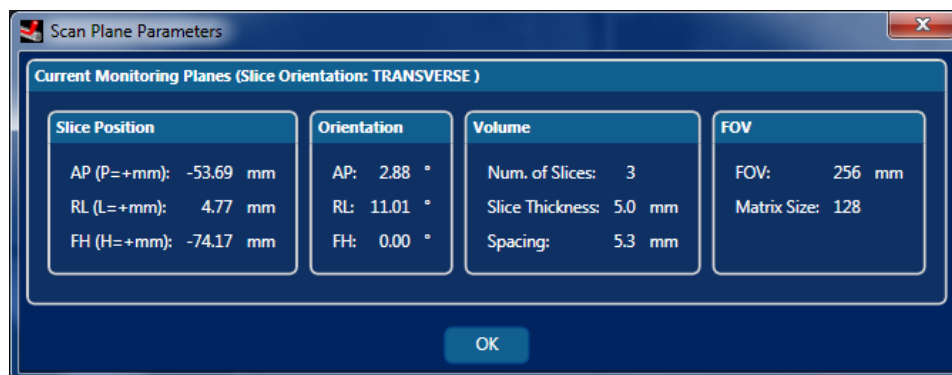

Enter the displayed scan plane parameters from Fusion-S (see Fig 8.8.2.2) into the NeuroBlate Thermal Monitoring Sequences protocol's geometry parameters in the MRI. This will be in the Offc/Ang tab of the sequence exam card as shown below. The Base plane or slice orientation is modified in the geometry tab as noted.

Stacks	1
Stack Offc. AP (P=+mm)	-40
RL (L=+mm)	0
FH (H=+mm)	-34.09
Ang. AP (deg)	0
RL (deg)	20
FH (deg)	30
Shim Size AP (mm)	60
RL (mm)	60
FH (mm)	60
Offc. AP (P=+mm)	-45
RL (L=+mm)	0.47
FH (H=+mm)	-32.47
Ang. AP (deg)	0
RL (deg)	20
FH (deg)	30

- Entering orientation values on Philips also requires the following steps in this order to ensure final entry is correct:
  - Enter the required slice orientation (coronal/ sagittal/ transverse)
  - Enter zero for all angles (AP, RL, FH) to reset entry
  - Enter the prescribed orientation angles (AP, RL, FH)

Shim Box notification:

Center Green Shim box over center of three thermal images

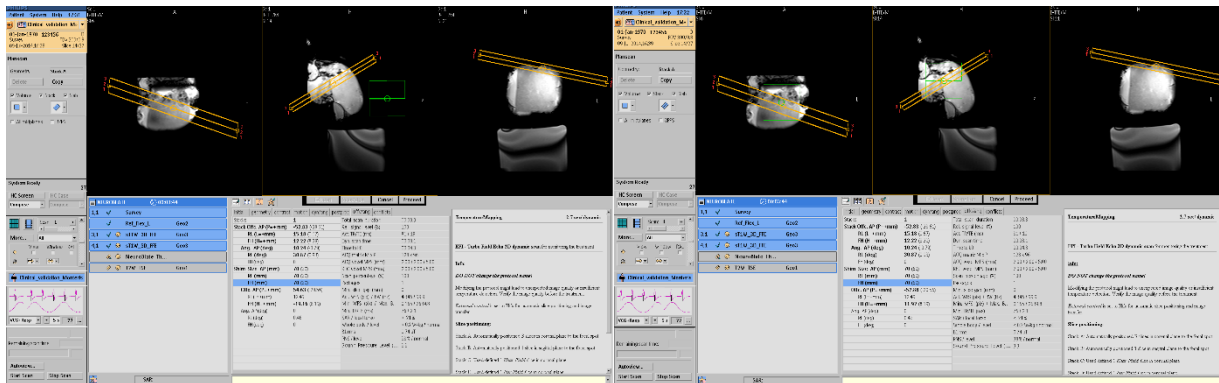

Incorrect Placement of Shim Box

Correct Placement of Shim Box

**Step 2:** Copy the same scan from step 1 to ensure all parameters are the same except for DynScans. Set the Dyn Scans = 512 (or more measurements than may be needed)

**Note:** This second scan, copied from first, provides the thermal data to Fusion-S in near real time and must have the exact same parameters as step 1.

**Note:** For Intera (1.5T) software version contiguous thermometry scan times may be limited

- Begin the “Header Scan” on the MRI as defined in Step 1 noted previously

### 8.8.4. Initiate Thermal Monitoring in Fusion-S

- Select the *Start* icon under the *Acquisition* heading on the Fusion-S the right screen menu

This triggers acceptance of this header scan by a DICOM push from the Philips MRI

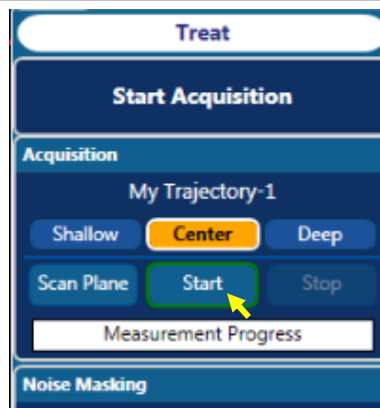

#### 8.8.4.1. For Philips MRI Only (for all other MRI types skip to 8.8.4.2)

- Once this “Header Scan” is complete, perform a DICOM push of this scan to the RTT DICOM node (‘RTT’ in DICOM node label) only AFTER “Start Acquisition” is pressed on Fusion-S

It is important to monitor the status of this transfer to ensure that it completes successfully prior to starting the next scan (step 2). The Queue Manager can be used to monitor the transfer completion.

#### For R3 or R4 MR Software:

- Click on System menu option and then on Queue Manager...

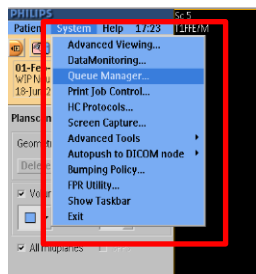

#### For R5 MR Software:

- Click on System menu option and then on Manage Job Queue...

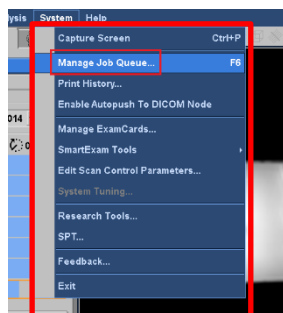

- Alternatively, click on Patient ->Administration, and then on the Queue Manager button shown by the red arrow below (similar feature on R3, R4, R5 software)

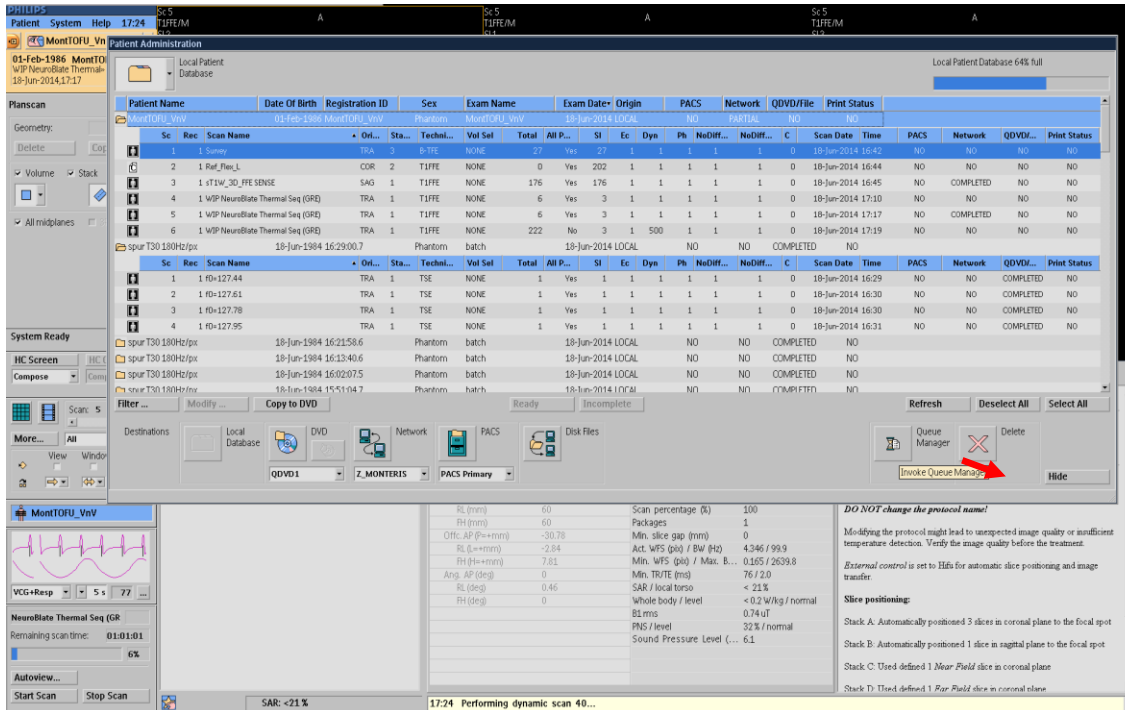

A finished transfer would be listed as **Finished**, and a pending one would be listed as **Executing** in the status column.

- Complete Step 2 as defined in 8.2.2.2 (Copy scan and Modify **only** Dyn Scans = 512)
- Start this second scan (step 2) on MRI

This triggers thermal data receipt at Fusion-S automatically. Do NOT perform image transfer manually from the Philips MRI (DICOM push) for this step.

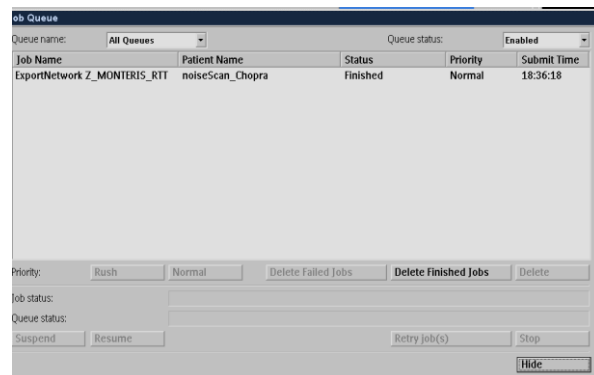

**WARNING:** On Philips MRI, the treatment slice orientation and position of the second Philips scan (step 2) **MUST** match the first “header” scan. The **ONLY** parameters that should change between each scan is the # dynamics. Use the sequence copy feature to “rerun” scan 1 with only this one parameter changed to ensure all other parameters match. Failure to ensure position and orientation are identical may cause thermal monitoring to be misaligned with the desired heating location.

**Note:** It is recommended that to stop thermal acquisition on Philips, the scan should be stopped first on the Philips MR console and then stop the acquisition receipt on Fusion-S (i.e. Select “Stop Acquisition” on Fusion-S) in this order.

### 8.8.4.2. Initiate Thermal Monitoring for all Other MRI Types

- Start acquiring the NeuroBlate Thermal Monitoring Sequence



**WARNING:** Treatment slice orientation and position must match the treatment planes shown in the views. The MR pulse sequence parameters other than orientation and position must not be changed and must adhere to the requirements for **NeuroBlate** treatment.



**WARNING:** Do NOT power ON the Interface Platform during MR imaging. Image quality may be compromised.

**Note:** For any given trajectory, upon successful receipt of the very first measurement from the MRI, the Fusion-S Software “locks” in the acquisition position and orientation and forces all subsequent acquisitions to be aligned precisely to this first accepted acquisition. All subsequent scans must have the same orientation; the position can only be shifted in equal multiples of the slice thickness and gap. No in-plane panning or shifting is allowed after the lock. Any incoming MR data will be rejected with a “position mismatch” error issued to the user if precise alignment to the first accepted scan is not followed.

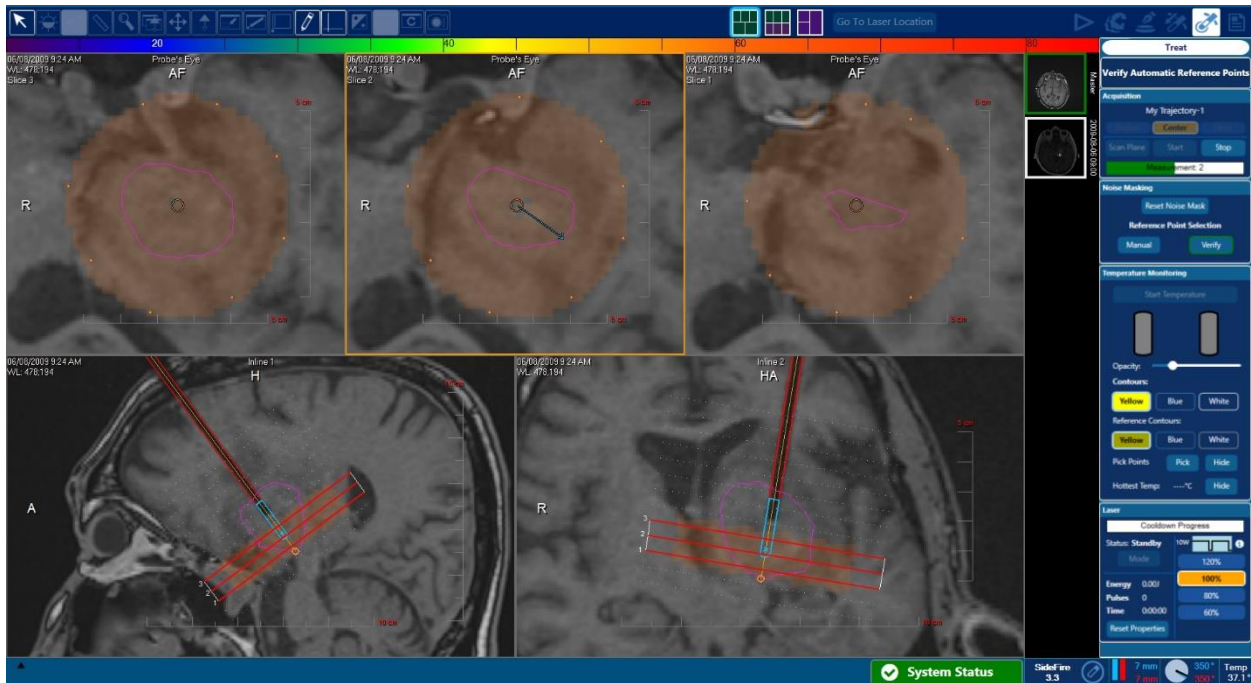

**Figure 8.8.3.21: Noise Mask and Reference Point Selection**

Once MR images begin arriving from the MRI (approximately every 8 seconds), the initialization phase will compute a noise mask and allow for reference point selection. The software receives data and updates the view with an orange-colored overlay indicating mask component pixels as shown in Figure 8.8.3.21.

The mask is a circular region (6 cm diameter) surrounding the LDP. It represents a sub region of the acquired MR images. Any data outside this region is ignored. The MR data measurements within the mask are analyzed and any pixel locations containing excessive phase noise will not be used (dropped) for temperature measurement. Pixels not used for temperature measurement are cleared or rendered transparent in the mask overlay as shown above where the pixels in the center of the mask in the first two image panes are dropped due to LDP void.

As the MR acquisition continues, the system will select 8 preset reference points surrounding the treatment area within each view as reference points. These reference points identify proton resonant phase drift inherent to the MRI scanner and compensates for it to help provide accurate thermal imaging. The reference points are placed at the periphery of the noise mask, away from and surrounding the target ablation zone. Depending on the case, at least 3 mm beyond the treatment area boundary (visual guideline – red beam line is 10 mm in length)

In the caution statement to follow, criteria is established for proper reference point placement. If the criteria is not met for any given point the point should be deleted and reselected.



**CAUTION: Reference Point Selection** is critical to accurate MR thermal imaging.

Reference points are used to compensate for normal phase drift of the MR system and thus their location is critical to accurate temperature monitoring. They should be selected within the brain tissue and outside the region of expected temperature increase using the following guidelines:

- Proximity to the probe should be greater than 15 mm and, depending on the case, at least 3 mm beyond the treatment area boundary (visual guideline – blue beam direction arrow is 15 mm in length)
- Points should surround the probe, as much as possible, in a single concentric ring
- Points should be located at least 2 mm from any potential anatomical influences (e.g. sulci, ventricles, midline gap, edge of brain, etc.)

If the user is not satisfied with or the criteria above is not met with any of the preset points, they can be manually selected using the following steps:

- Select *Manual* Under the *Noise Masking* heading on the Fusion-S the right menu bar
- Click on any of the auto-detected points to delete (deleted auto-detected points have their location blacklisted from being auto-selected again for that acquisition)

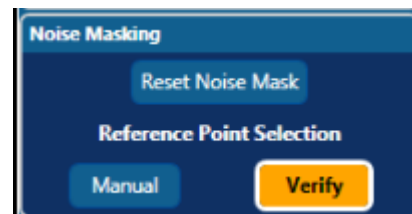

- Click to select 8 reference points at the periphery of the overlaid, orange Noise Mask in each of the three displayed image monitoring view panes - a total of 8 reference points (automatic and manual) is required for each of the three monitored view panes
- Click *Verify* when all the reference points have been set to the user's satisfaction:



Ensure the points are picked only within actual brain tissue (grey or white matter) avoiding sulci, blood vessels, ventricles and bone. To delete a reference point, right click on the reference point and click “delete”.

**Note:** Selecting the *Reset Mask* button will clear any masked regions and begin the noise and temperature masking stage upon the next measurement. It’s similar to beginning at measurement 1 in a new acquisition but does not require a reset of the current MR acquisition. This should only be used in cases where a significant noise event may have corrupted the data in a large portion of the view masking out key areas for treatment monitoring. Following the reset, 4 new measurements must be received before transition to temperature monitoring can occur. If regions of the view have been masked due to a poor reference point location selection, it is preferable to simply delete existing points and/or select new points since this forces a retroactive calculation of the data stability on the last 4 measurements and **does not need** new additional measurements.

In addition to reference points, a minimum of 4 measurements must be acquired before the user can proceed to temperature and thermal dosage monitoring.

- Under the Acquisition heading on the Fusion-S the right menu bar, Click Start Temperature.

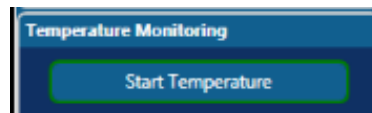

Prior to the display of color-coded temperature data within the mask region, user must confirm patient core body temperature before proceeding to temperature monitoring. Do not assume the default value of 37°C is correct. Patient core body temperature is used as the best estimate of local brain temperature, so its accuracy must be assured as a reference point for thermal dose monitoring. Under-treatment may occur if the body temperature value entered is greater than the patient’s actual body temperature. Over-treatment may occur if the body temperature value entered is less than the patient’s actual body temperature.

- Enter the current core body temperature in the new dialog box

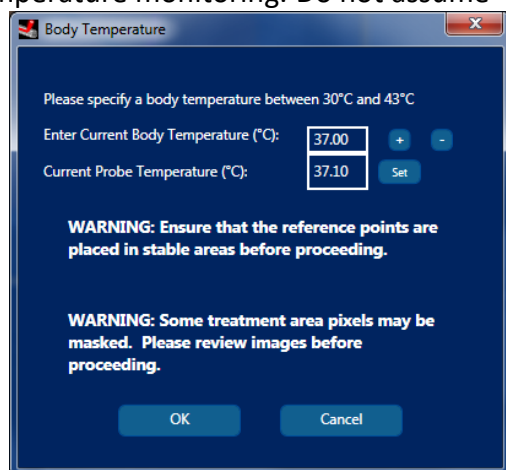

**CAUTION: Patient Body Temperature Entry** - This value should be found through direct measurement, not assumed. Incorrect body temperatures exceeding 39°C may affect the accuracy of the thermal dosage computation resulting in a poor prediction of thermal dose.

**WARNING:** Use extreme care when determining patient baseline core body temperature. Failure to determine an accurate value will result in improper performance of temperature monitoring software with the potential to cause patient injury.

**WARNING:** The temperature value indicated from the *NeuroBlate* laser probe is not an accurate measurement of core body temperature. Do NOT use this value.

Contact Monteris Medical for identification of methods for core body temperature monitoring.

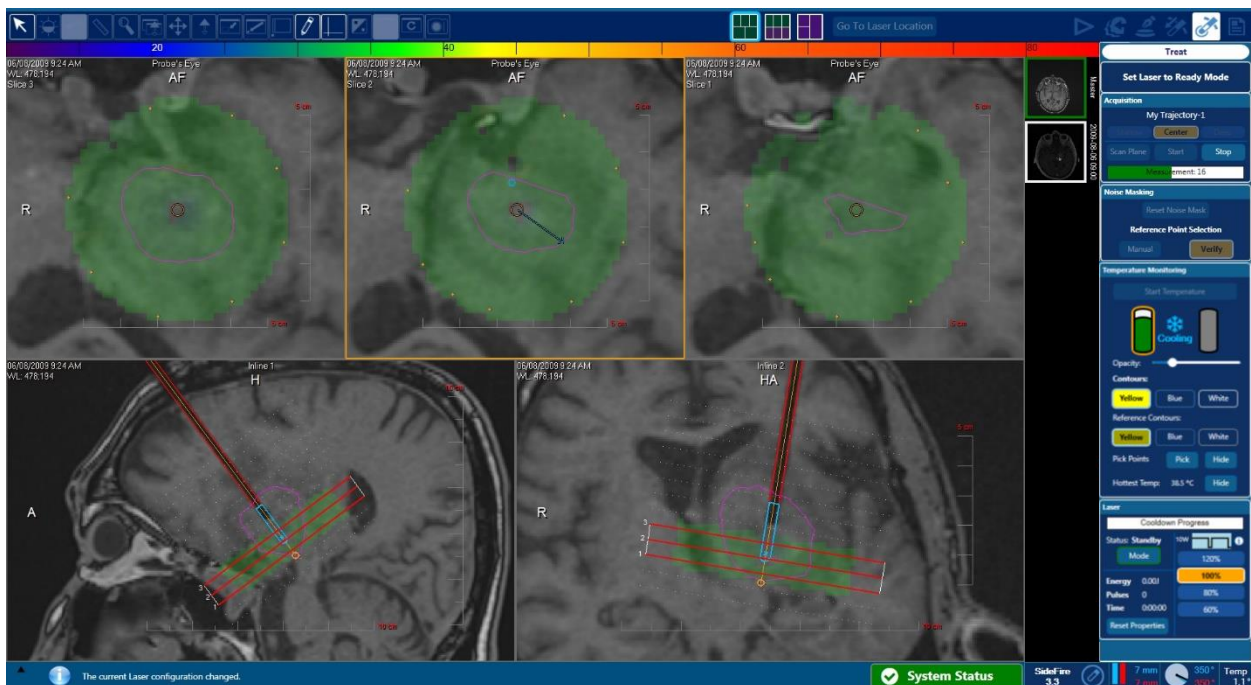

**Figure 8.8.3.22: Thermal Dosage Monitoring Display before Lasing**

The color overlay changes to green which represents the typical baseline body temperature (37 C) which corresponds to the colored temperature scale at the top of screen (Figure 8.8.3.22). LDP gas cooling is activated following user entry of body temperature reading. The pixels in the vicinity of the LDP will begin to shift from green to blue scale as the tissue cools around the LDP. Confirm that the LDP temperature falls to range of 0 to 5° C for the SideFire and 10 to 15° C for the FullFire. Contact Monteris Service if failure of LDP cooling prevents treatment.



**CAUTION:** If no tissue cooling is noted in the adjacent tissue surrounding the Software Rendered Probe, the user should verify that the thermal monitoring planes are properly positioned with respect to the laser exit location on the laser delivery probe before proceeding.



**CAUTION:** In the presence of thermal imaging pixel drop extending more than 3 mm away from the edge of the probe void, the user should ensure that the thermal monitoring planes are properly positioned with respect to the laser exit location on the laser delivery probe before proceeding.

- Select the desired *Laser Output* from the right-side menu:

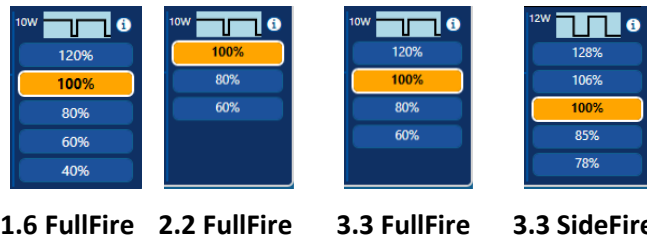

These settings represent different combinations of laser power and pulse settings to achieve varying energy output level. For the 1.6 FullFire, 40% power option is only available in SW v3.18



**WARNING:** To prevent patient injury, the user must confirm that the desired Laser Output setting is selected before delivering laser energy.

### 8.8.4.3. Initiate Delivery of Laser Energy to Tissue

Fusion-S monitors operating conditions including LDP cooling to define when laser can enter Standby mode. When operating conditions are normal and LDP has reached set-point cooling level, system will release the laser interlock allowing Standby mode activation. The user must enable energy delivery by switching to Ready mode via Mode button. Laser energy delivery is controlled by user depression of foot pedal.

- Select *Mode* under the *Laser* heading to switch laser from *Standby* to *Ready* in preparation for energy delivery

The foot pedal is active only when laser is in *Ready* mode. Once the LDP has cooled to its target range, the laser interlock switch will be released and the status switches from *Standby* to *Ready*.

- Depress foot pedal to initiate laser emission

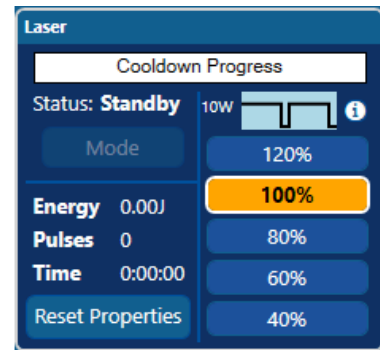

When the laser foot pedal is depressed, displayed mode will be set to *Laser* to demonstrate a visual indicator of laser emission and audible beeping will be heard to indicate that laser emission is active. If the foot pedal is released, the laser mode will revert to *Ready*. The values under *Properties* will update current values when laser is operational.

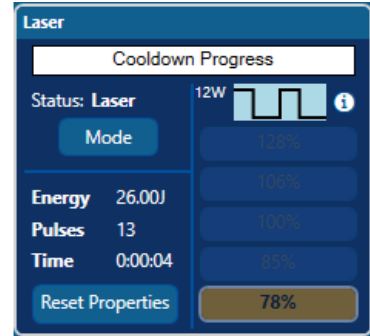

**CAUTION:** Do not initiate laser emission if the LDP is not inserted in tissue or before the LDP connections are made.



**CAUTION:** Immediately release the laser footswitch upon the display of any error condition.

- Continue laser emission while monitoring thermal dose contours overlaid onto thermal monitoring view-panes on the Fusion-S display screen



**WARNING:** To prevent patient injury, do not mechanically clamp down the laser footswitch during laser energy delivery.



**CAUTION:** During treatment: If there is concern for cranial bleeding, the user may consider acquiring blood-sensitive (GRE) MRI imaging in between laser shots at intervals throughout the procedure. This type of scan should be executed on the MRI only when linear or rotary probe motion is NOT active.

**CAUTION:** During treatment of neurological tissues adjacent to critical brain structures: as with all thermal procedures there is a risk of injuring adjacent structures. Careful planning should be done for targets that require treatment in these regions. Consideration should be given to limiting the development of the thermal dosage contour line adjacent to these structures because this also indicates increased temperature near the contour line boundary.

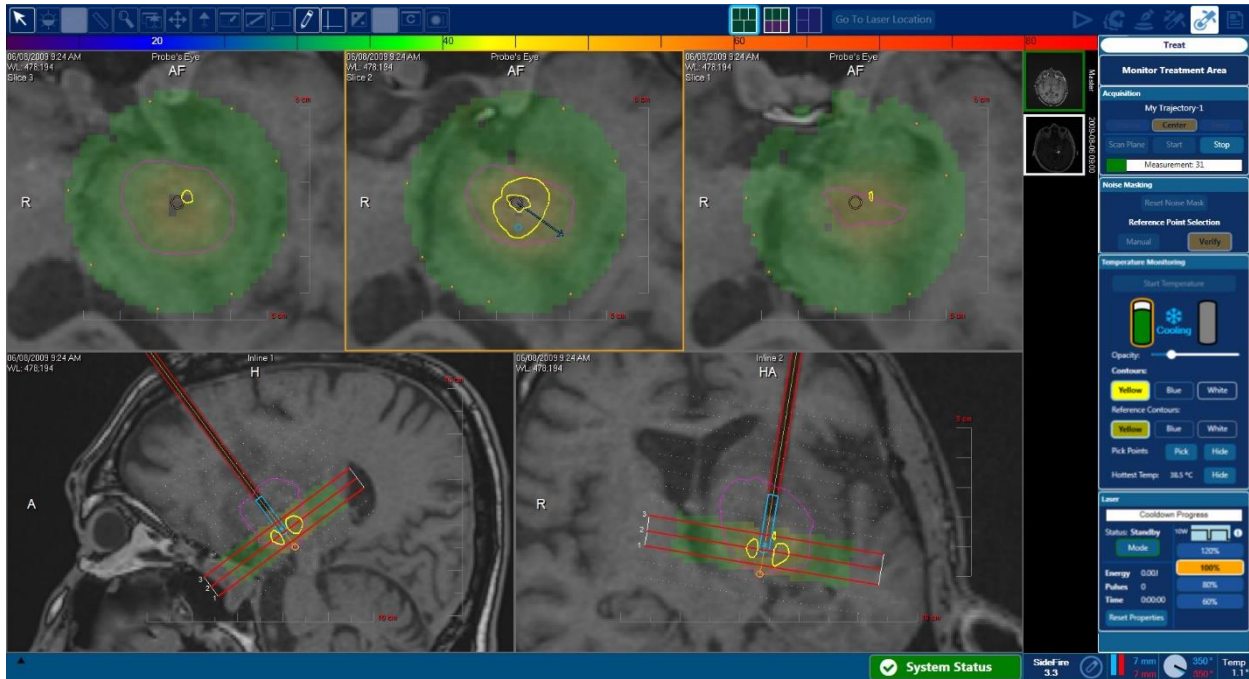

**Figure 8.8.3.31: Thermal Monitoring Display during Lasing**

During laser emission, temperature maps overlaid on the displayed monitoring images should show elevated temperature near the LDP (represented by red color scale). If after several thermal measurements no temperature elevation is seen adjacent to the software rendered probe, the user should discontinue laser delivery, verify that that the laser probe is receiving laser energy and ensure that the thermal monitoring slices are properly positioned with respect to the laser exit location on the laser delivery probe.

**WARNING:** To avoid equipment damage and patient injury, do not continue to deliver laser energy if no elevation in temperature is noted adjacent to the software rendered probe.

Pixels in the temperature map overlay where there is unstable MR phase data will not be displayed (will be dropped from view). If a pixel is noisy or potentially inaccurate, temperature data will not be collected from that pixel. Tissue voxels represented by dropped pixels may (or may not) be heating in that area. The user should proceed with extreme caution when pixel drop becomes extreme or is adjacent to critical structures.

Areas receiving a measured thermal dose will be depicted with a contour line boundary of the thermal isodose region. These are known as Thermal Dose Threshold (TDT) lines.

Under the Contouring Level heading in right menu, a threshold can be selected using the icons labeled Yellow, Blue or White which correspond to three unique thermal dose levels displayed as:

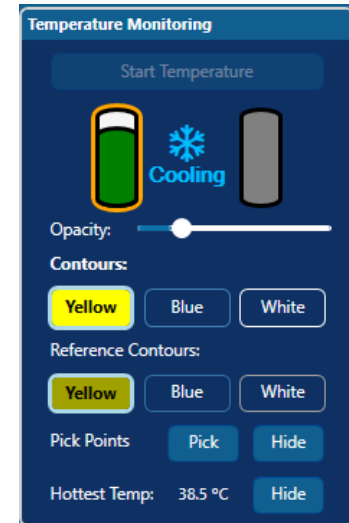

1. Yellow Thermal Dose Threshold: Contained tissue has been exposed to the thermal equivalent of 43°C for 2 minutes duration. Tissue outside the yellow contour lines has a higher probability of receiving no thermal damage. Tissue between the Blue and Yellow TDT lines may experience thermal damage; but cell death is uncertain.



**Caution:** During the ablation process, the Yellow TDT lines should be kept an appropriate distance (e.g., 1-3 mm) from eloquent structures or functional white matter tracts (i.e. corticospinal tract, optic radiations, arcuate fasciculus, corpus callosum, superior longitudinal fasciculus, etc). Fusion-S Software supports import of diffusion tensor imaging (DTI) data obtained using neuro-navigation software which may aid in monitoring of ablated areas near these critical tracts or cortex. Figure 8.8.3.32 illustrates an example of an imported DTI image of an eloquent structure and the appropriate distance to the yellow TDT line.

2. Blue Thermal Dose Threshold: Contained tissue has been exposed to the thermal equivalent of 43°C for 10 minutes duration. Tissue between the White and Blue TDT lines are likely to experience irreversible cell damage.



**Caution:** When choosing the Blue TDT line for monitoring the ablation zone, the user should be aware that there can be a  $\pm 1.5$  mm variance between the actual thermal dose and the Blue TDT line as depicted by the blue dashed line in Figure 8.8.3.33 during laser ablation.

3. White Thermal Dose Threshold: Contained tissue has been exposed to the thermal equivalent of 43°C for 60 minutes duration. All tissue within this boundary experiences cell death within  $\leq 48$  hours.

**Note:** Surgeons should utilize the appropriate Thermal Dose Threshold (i.e. Yellow, Blue) for monitoring the ablation zone based on the lesion pathology, location, surrounding tissue, and surgical goal. When near critical structures, TDT coverage may need to be adjusted in order to protect those structures.

**Note:** The user should be alert for rapid or unusual expansion of TDT lines in areas not adjacent to the LDP. Unusual TDT line expansion can be caused by factors other than tissue heating which cause MR phase disruption such as RF noise as well as air or blood. TDT lines that expand slower than expected may indicate a decrease or loss of laser power or functionality

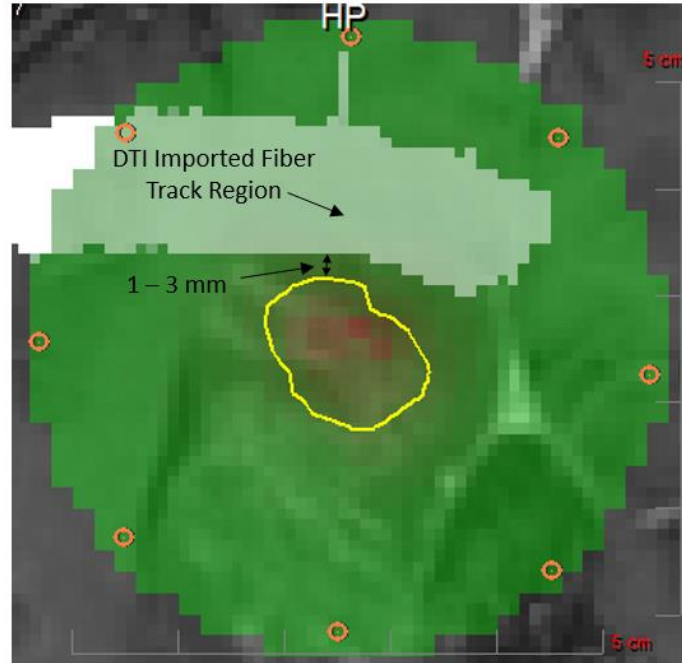

**Figure 8.8.3.32: Appropriate distance between yellow TDT line and eloquent tissue**

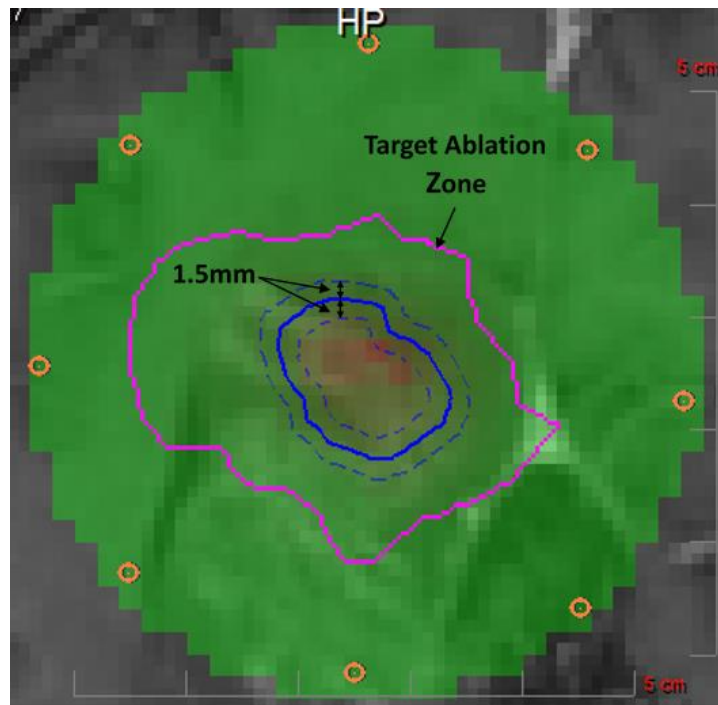

**Figure 8.8.3.33: Variance of blue TDT line**

**CAUTION:** If unexpected or unusual TDT line expansion is encountered (e.g. rapid and erratic or slower than expected), it is recommended that the user should stop thermal delivery and perform diagnostic MR imaging to evaluate the area in and around the target ablation zone.

**CAUTION:** During treatment near the brain surface, near bone, near large volumes of CSF, or near large blood vessels: Due to the non-homogenous conduction of heat in this type of anatomy, as well as the increased variability of MRI thermometry in areas of dissimilar tissues, there is a risk of damage to these adjacent tissues. Careful planning should be done for targets that require treatment adjacent to these tissues. Consideration should be given to limiting the development of the thermal dosage contour line adjacent to these structures.

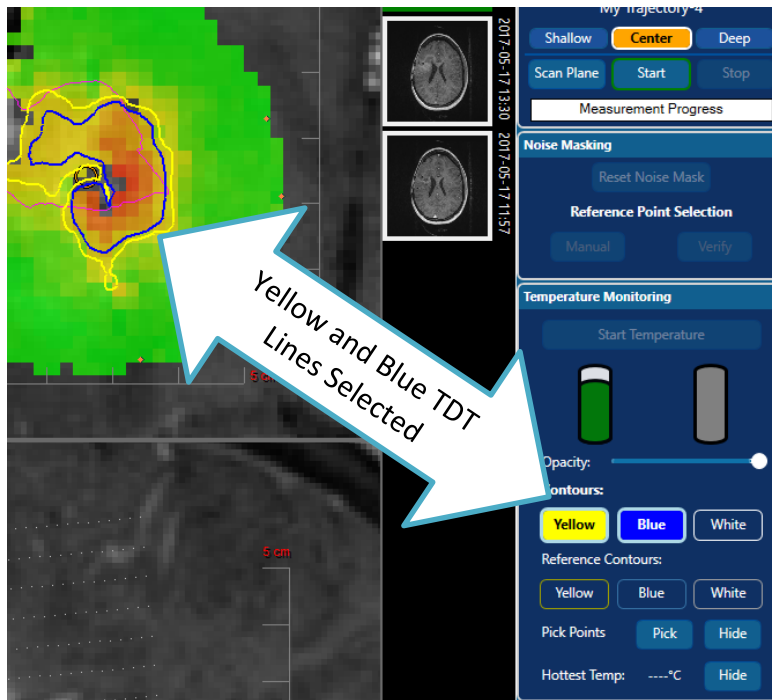

**Figure 8.8.3.34: Multiple TDT Contours**

Fusion-S software must have at least 1 TDT Line level selected. The software allows for up to 2 TDT Line levels to be selected at a time. When selecting a 3rd level, the oldest selected level is automatically deselected.



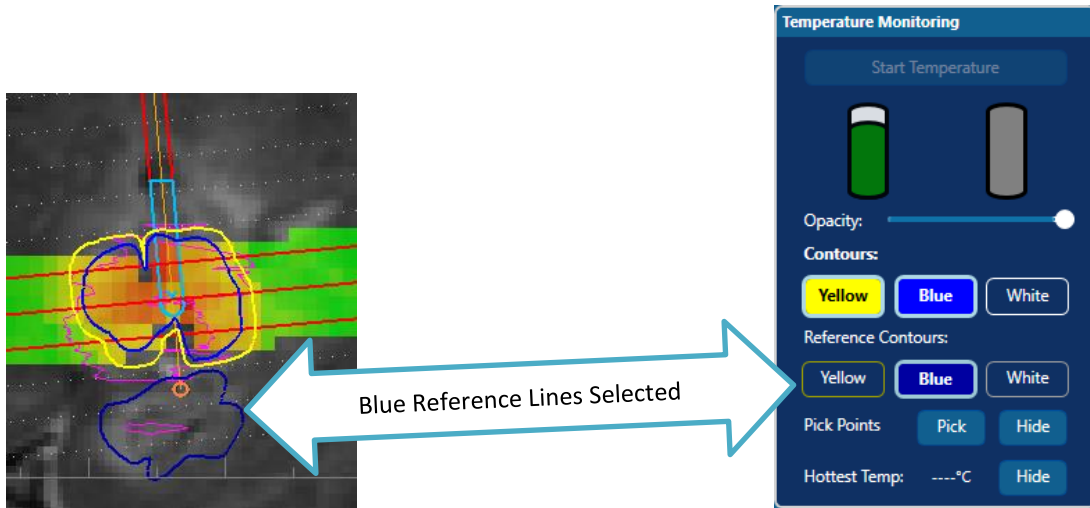

**Figure 8.8.3.35: Reference TDT Contours**

Reference TDT Lines are TDT Lines from a previous trajectory’s ablation or a reloaded profile’s ablation. Reference TDT Lines are selected independently of the Current TDT Lines. During acquisition only 1 Reference TDT Line level is selectable at a time (which defaults to *Yellow*). If no Reference TDT contour level is selected, they are hidden. For SW v3.18 when outside acquisition up to 3 Reference TDT levels may be selected simultaneously. When acquisition starts, the lowest threshold level (*Yellow* is lowest, *White* is highest) will be used (or none if none were selected).

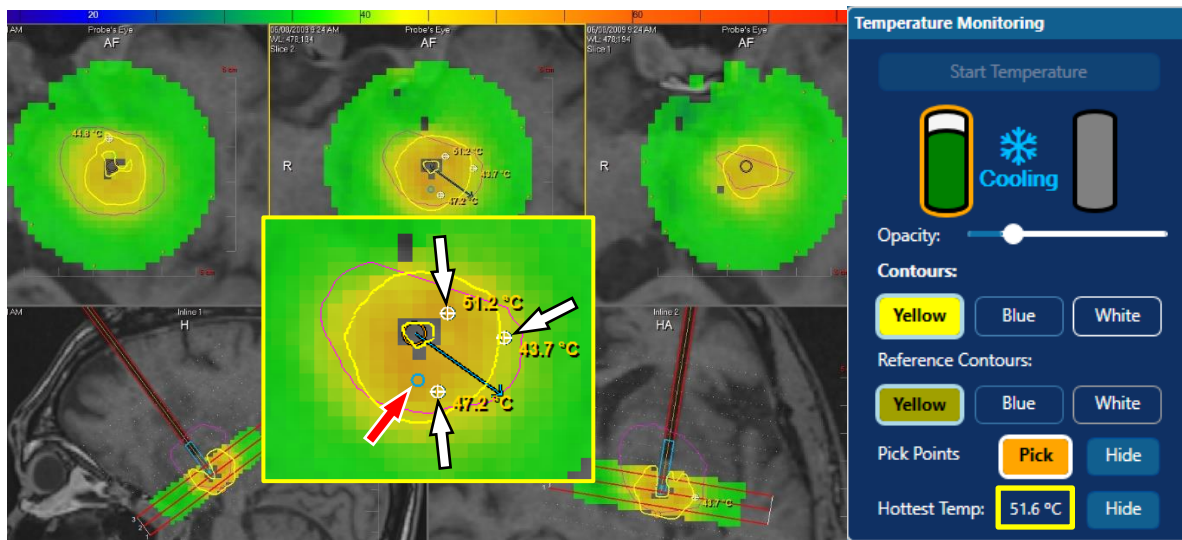

**Figure 8.8.3.36: Hottest Temperature Monitoring**

The Fusion-S Software constantly monitors for the hottest pixel located 4-6 mm (3 pixels) from the outer surface of the probe tip. The hottest point will adjust its position if this point changes and is displayed as a light blue circle overlaid on the Temperature Mask (red arrow Figure 8.8.3.34). The temperature at the hottest pixel will be displayed under the Temperature Monitoring heading next to *Hottest Temp*: (yellow box Figure 8.8.3.34).

- If the temperature at this location exceeds 85°C or should all pixels 4-6 mm (3 pixels) from the outer surface of the probe tip drop from view, stop firing the laser immediately by releasing the foot pedal switch while maintaining MRI acquisition and internal probe cooling

**Note:** The outer surface of the probe, is depicted as an orange circle at the center of the Temperature Maps in the Probe’s Eye views

Temperature “Pick Points” (white arrows Figure 8.8.3.36) can be placed by selecting the  icon and clicking locations in the temperature mask within any desired view pane. The pick point will report the temperature of the selected pixel. There is no limit to the number of points allowed.

Selecting the Hide button will toggle between showing or hiding all pick points. A temperature pick point can be moved to a new location by dragging it while the Pick button is selected. Clicking the point again will remove it.



For SW v3.17 A warning can be set for any temperature pick point by right-clicking on the point, selecting *Warn At* and entering a temperature (image above). When the specified temperature is reached, the pick point will change color and a warning message will appear (image below).

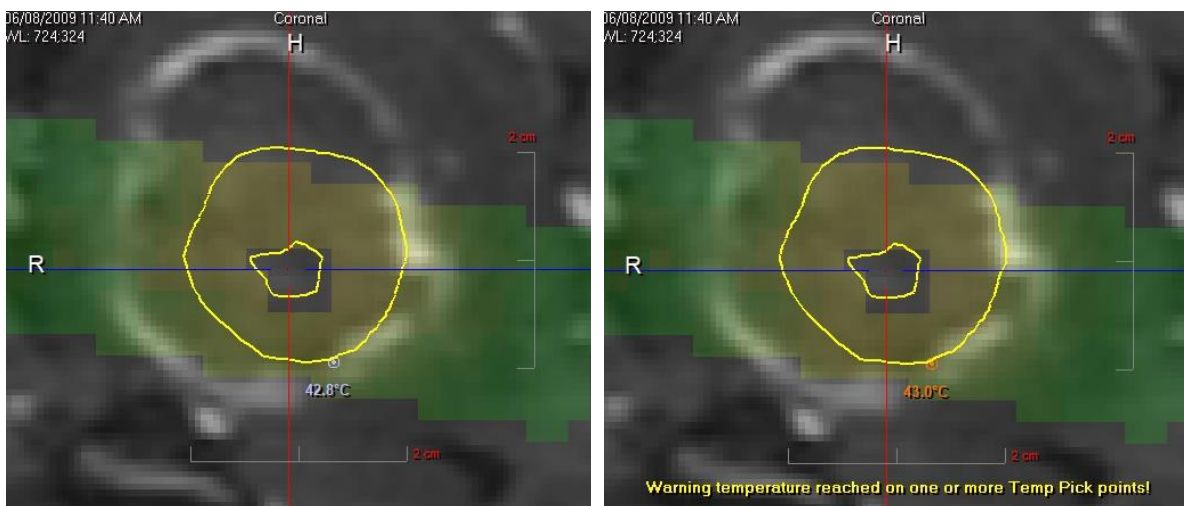

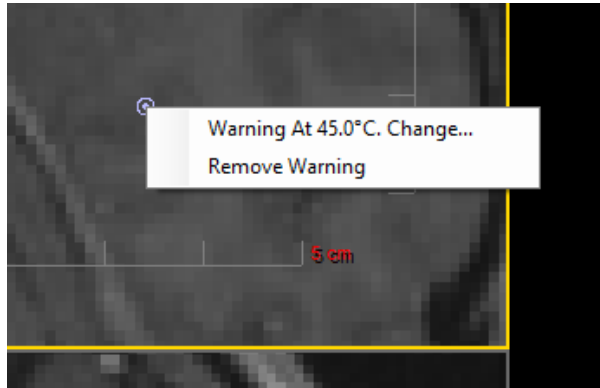



Right-click on the point again to display options which will change the warning temperature or remove the warning.

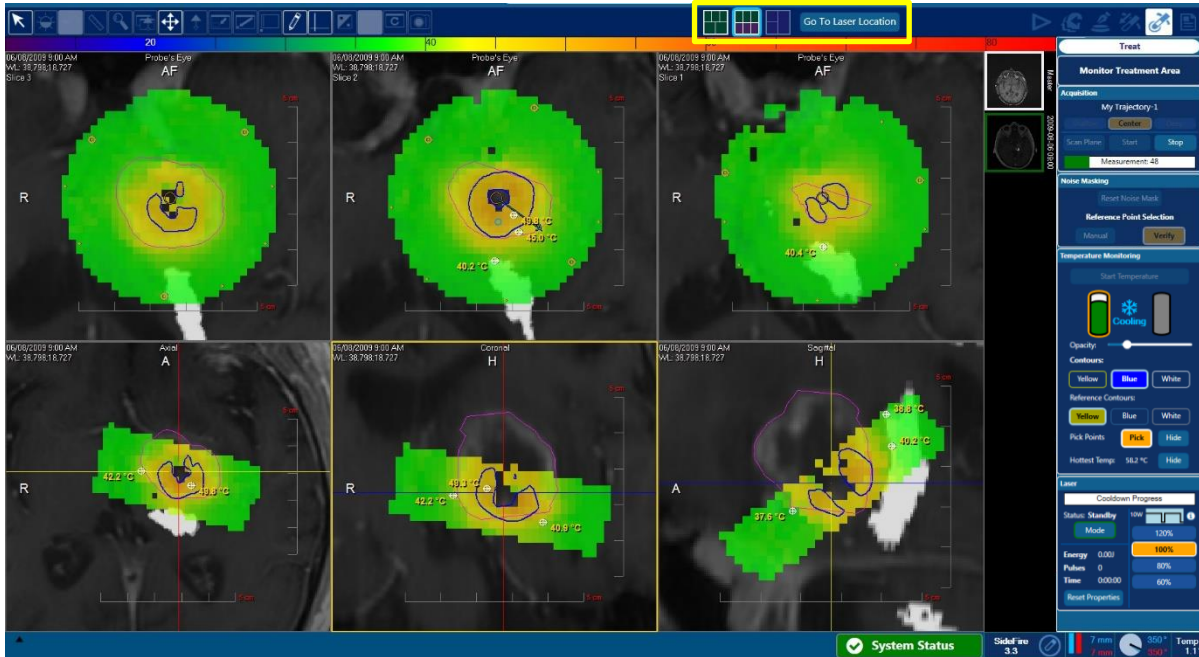

For SW v3.18 The warning can be set to disable the laser at a desired temperature by right-clicking the *Stop Laser* checkbox and entering a temperature. When the specified temperature is reached, laser actuation will stop.



**Figure 8.8.3.37: Orthogonal View Screen (available during laser actuation)**

An alternative monitoring view screen is available during laser actuation which changes the bottom inline views to Axial, Coronal, Sagittal orthogonal views. Switch to this view by selecting the  icon the top of the screen (Figure 8.8.37). The **Go To Laser Location** icon will center the orthogonal views on the laser exit position.

A third view screen is available whenever the laser foot pedal is released which displays purely anatomical views (Figure 8.8.36). The view screen will automatically switch back to the last viewed screen upon actuation of the laser foot pedal.

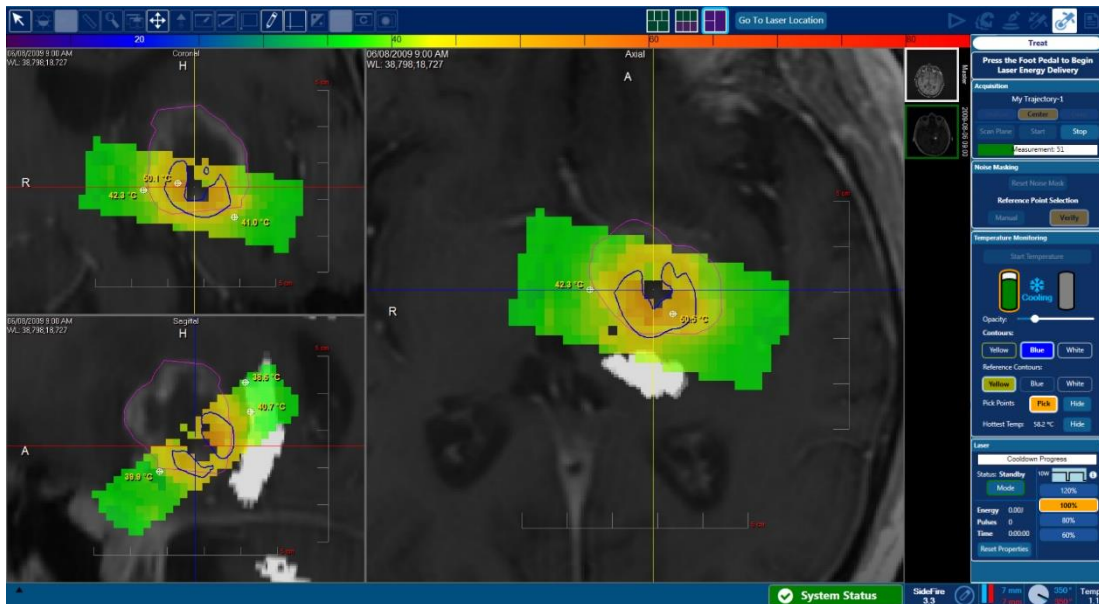

**Figure 8.8.3.38: Anatomical view showing 3 orthogonal planes (available only when laser off)**

When using the SideFire Laser Probe, angular orientation can be changed while delivering laser energy by clicking the laser direction arrow and dragging it to a new orientation. This is not relevant to the FullFire given that it is not directional.

If a new linear position is desired for continuing thermal treatment or if the MR thermal acquisition needs to be stopped and restarted for any reason:

- Stop thermal delivery by releasing the laser foot pedal
- Allow MRI to continue acquiring the NeuroBlate Thermal Monitoring Sequence to allow all heated tissue to return to baseline temperature

For tissue adjacent to the probe, this may require up to 120 seconds. Tissue further away from the probe may take longer to return to baseline temperature. A *Cooldown* status bar displays a 120 second countdown when the foot pedal is released.

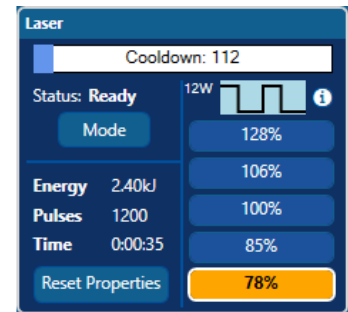

**Note:** Internal probe tip cooling continues throughout the MR thermal acquisition even when the laser foot pedal is released. It is only stopped when receipt of MR thermal data stops or whenever a system fault occurs which immediately disables the laser and cooling functions.

A warning dialog box will appear if *Stop Acquisition* is selected prior to the Cooldown status reaching 0

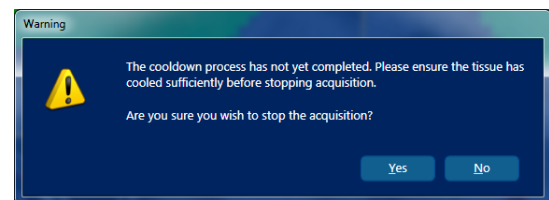

**WARNING:** If a system fault occurs, cooling is turned off to ensure patient safety until the cause of the fault can be addressed and the system restarted. However, this means there is no active cooling and tissue may take longer to return to baseline temperature. It is important that you keep the MRI running until the tissue has cooled to baseline, as this will result in correctly calculated thermal dose. Failure to keep the MRI running may result in the inaccurate calculation of thermal dose levels which may lead to patient injury.

If the MRI acquisition was halted prior to tissue returning to baseline, ensure the probe tip temperature returns to baseline temperature prior to re-initiating MR scanning, probe cooling or laser ablation.



**WARNING:** Failure to allow all heated tissue to return to baseline temperature prior to stopping MR acquisition may result in inaccurate calculation of thermal dose levels which may lead to patient injury. Maintain MRI acquisition (which ensures internal probe cooling) to allow tissue next to the probe to cool to the baseline temperature which may require up to 120 seconds. Tissue further away from the probe may take longer to return to baseline temperature. The Temperature Pick Points and the temperature map can be used to monitor all tissue.

- Stop acquiring the NeuroBlate Thermal Monitoring Sequence on the MRI and select Stop Acquisition under the Monitoring Status heading on the Fusion-S right menu bar
- To continue treatment at a new linear position, user must stop the MRI acquisition and select Stop Acquisition in Fusion-S.



**CAUTION:** It is recommended that to stop thermal acquisition on Siemens MRI, first stop the scan on the MR console and then stop acquisition receipt on Fusion-S (i.e Select “Stop Acquisition” on Fusion-S) in this order.

**Note:** If the LDP is changed to a new size or type, the Laser and Cooling protocols will be updated accordingly upon connection of the new LDP. Any time a LDP is changed within the Treat step, a self-test is recommended to ensure the efficacy of the LDP

To ablate a new area along a new trajectory, repeat workflow steps starting at section 8.5 Trajectory Confirmation (excluding the volume definition if treating the same lesion).

Once all desired treatment slices and angular positions of the probe have been used to optimize the desired coagulation result, the user can select end treatment at any time. Any running MRI acquisition should be stopped after all tissue returns to baseline temperature. Tissue further away from the probe may take longer to return to near baseline temperature. Use the Pixel Temperature Query tool and the temperature map to monitor temperatures of all tissue.

The probe can then be detached from the RDP Follower by depressing the green locking button and the patient can be prepared for burr hole closure by removing the probe from the patient.



**CAUTION:** The probe must first be detached from the RPD Follower before removing from the patient. Do not remove the probe from the patient while still attached to the RPD Follower.

Post treatment MR imaging such as blood sensitive GRE imaging may be used to identify any immediate effect.

## 9. Electrical System Requirements and Technical Data

- Class 1, with protective earth, protection against electric shock
- Type CF degree of protection against electric shock
- Input voltage: 120 V AC, 10 A, single phase, 50/60 Hz through a medical grade power cord.
- IPX0 degree of protection against ingress of water
- Laser class 4
- Inlet CO<sub>2</sub> pressure gauges for each tank read >4500 kPa (>650 psi) to max 6000 kPa (880 psi)
- The Electronics Rack provides continuous power to all internal rack components, to the external Control Workstation (Gen 3) (24 volts DC, medical grade) and to the Interface Platform (48 volts DC and 12 volts DC, medical grade).

**Table 9.1: Electronics Rack Data**

Electrical Connection Data	
Voltage	120 VAC
Current	10 A
Number of Phases	1
Frequency	50/60 Hz
Class	Class I Equipment
International Protection rating	IPX0
UPS time out	After 8 minutes operating on battery power

**Table 9.2: Control Workstation Data**

Electrical Connection Data	
Class	Class I Equipment
International Protection rating	IPX0
Power Source (Gen 3)	Electronics Rack
Power Source for Control Workstation (Gen 4) peripherals (display and KVM only)	Input voltage: 120 V AC, 5 A, single phase, 50/60 Hz, non-medical grade power cord

**Table 9.3: IEC 60601-1:2007 Tables**

IEC 60601-1-2:2007 Table 1 Requirements

The equipment is intended for use in the electromagnetic environment specified below. The customer or the user of the equipment should assure that it is used in such an environment.		
Emissions test	Compliance	Electromagnetic environment – guidance
RF emissions CISPR 11 CISPR 22	Group 1	The equipment uses RF energy only for its internal function. Therefore, its RF emissions are very low and are not likely to cause any interference in nearby electronic equipment.
RF emissions CISPR 11 CISPR 22	Class A	The equipment is suitable for use in all establishments other than domestic, and may be used in domestic establishments and those directly connected to the 120 Vac, 60 Hz public low-voltage power supply network that supplies buildings used for domestic purposes, provided the following warning is heeded: <i>Warning: This equipment/system is intended for use by healthcare professionals only. This equipment/system may cause radio interference or may disrupt the operation of nearby equipment. It may be necessary to take mitigation measures, such as re-orienting or relocating the equipment or shielding the location.</i>
Harmonic emissions IEC 61000-3-2	Not Applicable	
Voltage fluctuations/ flicker emissions IEC 61000-3-3	Not applicable	

IEC 60601-1-2:2007 Table 2 Requirements:

The equipment is intended for use in the electromagnetic environment specified below. The customer or the user of the Equipment should assure that it is used in such an environment.			
Immunity test	IEC 60601 test level	Compliance level	Electromagnetic environment – guidance
Electrostatic discharge (ESD) IEC 61000-4-2	±6 kV contact ±8 kV air	±6 kV contact ±8 kV air	Floors should be wood, concrete or ceramic tile. If floors are covered with synthetic material, the relative humidity should be at least 30 %.
Electrical fast transient/burst IEC 61000-4-4	±2 kV for power supply lines ±1 kV for input/output lines	±2 kV for power supply lines ±1 kV for input/output lines	Mains power quality should be that of a typical commercial or hospital environment.
Surge IEC 61000-4-5	±1 kV line(s) to line(s) ±2 kV line(s) to earth	±1 kV line(s) to line(s) ±2 kV line(s) to earth	Mains power quality should be that of a typical commercial or hospital environment.
Voltage dips, short interruptions and voltage variations on power supply input lines IEC 61000-4-11 UT = 120 Vac	<5 % UT (>95 % dip in UT) for 0,5 cycle 40 % UT (60 % dip in UT) for 5 cycles 70 % UT (30 % dip in UT) for 25 cycles  <5 % UT (>95 % dip in UT) for 5 sec	<5 % UT (>95 % dip in UT) for 0,5 cycle 40 % UT (60 % dip in UT) for 5 cycles 70 % UT (30 % dip in UT) for 25 cycles  <5 % UT (>95 % dip in UT) for 5 sec	Mains power quality should be that of a typical commercial or hospital environment. This device incorporates an uninterruptible power supply or a battery allowing for up to X minutes of operation.(where X is defined in documentation)
Power frequency (60 Hz) magnetic field IEC 61000-4-8	3 A/m	100 A/m	Power frequency magnetic fields should be at levels characteristic of a typical location in a typical commercial or hospital environment. However, may be exceeded due to normal MRI environment.



## IEC 60601-1-2:2007 Table 3 Requirements:

The equipment is intended for use in the electromagnetic environment specified below. The customer or the user of the equipment should assure that it is used in such an environment.			
Immunity test	IEC 60601 test level	Compliance level	Electromagnetic environment – guidance
Conducted RF IEC 61000-4-6	3 Vrms 150 kHz to 80 MHz outside ISM bands <sup>a</sup>	3 Vrms	Portable and mobile RF communications equipment should be used no closer to any part of the equipment including cables, than the recommended separation distance calculated from the equation applicable to the frequency of the transmitter.  Recommended separation distance $d = \left(\frac{3,5}{V_1}\right)\sqrt{P}$ $d = \left(\frac{12}{V_2}\right)\sqrt{P}$ $d = \left(\frac{12}{E_1}\right)\sqrt{P} \quad 80 \text{ MHz to } 800 \text{ MHz}$ $d = \left(\frac{23}{E_1}\right)\sqrt{P} \quad 800 \text{ MHz to } 2,5 \text{ GHz}$ where $P$ is the maximum output power rating of the transmitter in watts (W) according to the transmitter manufacturer and $d$ is the recommended separation distance in metres (m) <sup>b</sup> . Field strengths from fixed RF transmitters, as determined by an electromagnetic site survey <sup>c</sup> , should be less than the compliance level in each frequency range <sup>d</sup> .  Interference may occur in the vicinity of equipment marked with the following symbol:  Interference may occur in the vicinity of known RF transmitting devices and equipment marked with the following symbol:  
	10 Vrms 150 kHz to 80 MHz in ISM bands <sup>a</sup>	10 Vrms	
Radiated RF IEC 61000-4-3	3 V/m 80 MHz to 2,5 GHz	10 V/m	
NOTE 1 At 80 MHz and 800 MHz, the higher frequency range applies.			
NOTE 2 These guidelines may not apply in all situations. Electromagnetic propagation is affected by absorption and reflection from structures, objects and people.			
<sup>a</sup> The ISM (industrial, scientific and medical) bands between 150 kHz and 80 MHz are 6,765 MHz to 6,795 MHz; 13,553 MHz to 13,567 MHz; 26,957 MHz to 27,283 MHz; and 40,66 MHz to 40,70 MHz.			
<sup>b</sup> The compliance levels in the ISM frequency bands between 150 kHz and 80 MHz and in the frequency range 80 MHz to 2,5 GHz are intended to decrease the likelihood that mobile/portable communications equipment could cause interference if it is inadvertently brought into patient areas. For this reason, an additional factor of 10/3 has been incorporated into the formulae used in calculating the recommended separation distance for transmitters in these frequency ranges.			
<sup>c</sup> Field strengths from fixed transmitters, such as base stations for radio (cellular/cordless) telephones and land mobile radios, amateur radio, AM and FM radio broadcast and TV broadcast cannot be predicted theoretically			

## 10. Technical Support

Contact Monteris Medical Customer Support to request service or to report an adverse event:

- **Monteris Medical Toll-Free Customer Support: 1-866-799-7655**  
Callers may choose to be connected directly to a Technical Services Representative, to leave a message requesting service or product sales, or be connected to the Monteris Medical operator for further assistance.
- **Monteris Medical Email Reporting System:** [reporting@monteris.com](mailto:reporting@monteris.com)  
Contact Monteris via email to request service, make product improvement suggestions, report system issues, or register complaints.

## 11. Contact Information

---

### 11.1. DISTRIBUTOR/REP CONTACT:

---

Monteris Medical Corporation  
131 Cheshire Lane  
Suite 100  
Minnetonka, MN 55305  
(763) 253-4710 / (866) 799-7655  
[reporting@monteris.com](mailto:reporting@monteris.com)

---

### 11.2. MANUFACTURED BY:

---

Monteris Medical Corporation  
131 Cheshire Lane  
Suite 100  
Minnetonka, MN 55305  
(763) 253-4710 / (866) 799-7655  
[www.monteris.com](http://www.monteris.com)

## 12. Tips and Troubleshooting

Contact your local Monteris Medical Representative for system troubleshooting information or contact:

**Monteris Medical Customer Support: 1-866-799-7655**

Callers may be connected to a Technical Services Representative, to leave a message requesting service or product sales, or be connected to the Monteris Medical operator for further assistance.

**Table 12.1: Software Tips**

Tips	Workflow Task
Plug in the interface platform as early as possible (including IMRIS, as appropriate).	IP
When rebooting the Interface platform; allow 5 seconds before plugging it back in or restarting.	IP
Make sure that clocks between MRI and Main PC are synchronized.	NA
Perform a PACS network connection prior to starting the procedure.	NA
Allow the images and renderings in all view panes to be completely refreshed before interacting with them.	All
Refresh the displays by selecting the currently highlighted thumbnail; or the <i>Master</i> if none selected.	All
Don't import CT image data via PACS. Load CT DICOM files from a CD using the File-Load menu option.	Registration
Don't select a profile for import that is already in your plan directory.	Registration
Don't use Auto Register if you have a "slab" image dataset (image set that does not include the entire head).	Registration
Only switch the <i>Master</i> dataset if you have a different frame of reference.	Registration
Just before starting the MRI Acquisition in which you're going to capture a partially inserted LDP, note the current linear position. When you're aligning the software rendered probe to the LDP signal void; ensure that the software rendered linear position matches the recorded value.	Insert
Don't turn on IP screen while an RPD move is in progress, or an Interface Platform Communication Error is possible.	Insert Treat
Don't adjust the LDP linear and/or rotary position while an adjustment is already in progress.	Insert Treat
Don't change the zoom/pan level when waiting for RTT data import.	Treat
Don't make linear positional changes in Treat.	Treat
Avoid any interaction with the software during thermal image refresh (end of each 8 sec acquisition to the point where the TDT lines are updated).	Treat

**Table 12.2: Troubleshooting**

<b>Problem</b>	<b>Check / Action</b>	<b>Recourse</b>
The Commander does not lock in place	Ensure that the mounting holes on the bottom of the Commander are positioned properly over the IP Mounting Posts (See Figure 35)	If the problem persists, replace the RPD and contact Monteris
The Position Feedback Plug does not connect to its receptacle on the IP	Ensure alignment markers on the outside of the plug and receptacle are properly aligned	If the problem persists, replace the RPD and contact Monteris
The Interface Platform Display does not show Follower positions	Ensure the display is turned on.	Press the IP power button
	If the Display reads, "Error: Check Connection", ensure the Position Feedback Plug is properly connected	Unplug and re-plug the Feedback Plug - If the problem persists, replace the RPD and contact Monteris
	If the Display reads "Error: CRC", replace the RPD	Replace the RPD and contact Monteris
The Interface Platform Display shows unexpected characters	Press the power button once to turn OFF the display - Press the button one more time to turn the display ON again	If the problem persists, contact Monteris
The Follower does not move (linearly or rotationally) when the knob on the Commander is turned	Confirm the Locking Interface on the Follower is not at one of its limits: - Linear position at 0 or 40 mm o - Rotational position of 10° or 350°	Rotate the knob in the opposite direction. If the situation persists, replace the RPD and contact Monteris
The knobs on the Commander resist turning	Ensure the knob is being pressed in while turning to unlock	Replace the RPD and contact Monteris
The LDP Cooling Connector Plug does not insert into its receptacle on the IP Connector Box or will not stay retained	Ensure there are no burrs or defects on the Cooling Connector.	If there are any defects, replace the LDP and contact Monteris
	Ensure proper insertion of plug into the receptacle.	Push in until receptacle sleeve moves and then confirm plug clicks and locks. If the problem persists, replace the LDP and contact Monteris
The RPD has difficulty achieving the desired position	Carefully remove the RPD Commander from the IP, twist it 360 degrees in a direction that reduces any twisting strain on the umbilicals and reattach to IP	If the problem persists, use manual manipulations or replace the RPD